



**Johnson
Screens**

Industrial Screens



A brand of
Aqseptence Group

Johnson Screens Industrial Products



Innovative Design

Johnson Screens' stainless steel Vee-Wire® filter elements for liquid/solid and gas/solid separation that is known for great strength, a long service life and a high level of adaptability.

Vee-Wire screens are made by welding our patented V-shaped wire onto various sizes and shapes of support rods. This process creates a slot that enlarges inwardly, creating a large open area and clog-resistant surface. Our continuous welding method meets the most demanding standards for ruggedness, durability, resistance to abrasion, consistency and slot openings.

Custom Designed and Engineered

Each project is engineered to ensure it meets required specifications. We provide guidance and support from project conception to completion.

Lower Maintenance

The rugged construction and high quality of the materials produce a product that lasts longer and requires less maintenance.

Less Costly

Superior operating efficiency, reduced maintenance needs and extended service life, combine to lower costs to plant operators.

Many Construction Options

Screens can be used for:

- Direct screening
- Filter media support (sand bed, activated carbon, resins, catalysts)

Screens are available in slot opening from 25 µm up to 0.984 in. The most common materials used are the 300 series stainless steel, but many exotic alloys are available to meet specific applications.

Screens are available in a variety of shapes, including:

- Cylinders
- Flat or curved panels
- Cones
- Any form specific to a given application

The flexibility of the process allows the manufacture of custom-made screens for all applications types, such as new plant, expansions or upgrades.

A Highly Technical Product

The design and manufacturing characteristics of Vee-Wire surfaces, provide the following advantages:

- Non-clogging surface
- Large open area
- Low pressure drop
- Hydraulic efficiency
- High flow rates
- Mechanical strength
- Abrasion resistant
- Easy cleaning

Quality

Johnson Screens has been delivering reliable screens to various industries for more than a century, and though technology has changed, our commitment to quality products and services has not.

As an ISO certified company, each product is subject to a procedure of self-inspection by each operator throughout the manufacturing process. A final inspection guarantees delivery of a product that fully meets the user's specifications.

Johnson Screens can provide the following documents upon request:

- Quality plan
- Manufacturing plan
- Production schedule
- Process qualification record (PQR)
- Welding procedure specification (WPS)
- Welder performance qualification (WQR)
- In-house inspection reports
- Chemical and/or mechanical analysis certificates

Field Service

Johnson Screens offers a complete field service team of specialized and experienced members that are available for various projects including:

- Full installation
- On-site repairs
- Technical assistance or expertise
- Work supervision
- Inspection

Johnson Screens' experienced welder/fabricators team are available for onsite installation, repairs and screen replacement, and can be available within 24 hours for emergency situations or scheduled as needed.

Industry Areas

The strength, precision and design flexibility that characterize Johnson Screens brand of products, make them the choice in a broad range of industries.

Industries

- Water and wastewater
- Pulp and paper
- Chemical
- Petrochemical
- Water supply
- Mineral and aggregate processing
- Plastics extrusion
- Machine coolant filtration
- Architectural

Processes involving any aspect of liquid/fluid/solid separation, Johnson Screens has products and experience to help achieve maximum efficiency and effectiveness.

Applications

- Separating
- Filtering
- Media retention
- Sizing
- Dewatering
- Classifying
- Straining
- Drying
- Water intake
- Fish diversion
- Collection

The ability to evaluate the condition of screens and make recommendations as to the best course of action, our field service team will be there to allow the screens to operate at maximum capacity.

Whether cleaning, making minor or major repairs, or completely replacing screens, our technicians are equipped with all the tools, equipment and experience needed to provide the best field service available.

Johnson Screens' experienced technicians are also available for supervision of installations and on-site repairs.

Cylindrical Screens for Outside to Inside Filtration Flow

Standard

External circumferential wire and axial internal support rods.

Benefit

- Economical
- Suitable for most applications
- Precision openings

Product

- Filter cartridges
- Candle filters
- Header laterals
- Rotating drum screens
- Nozzles
- Resin traps

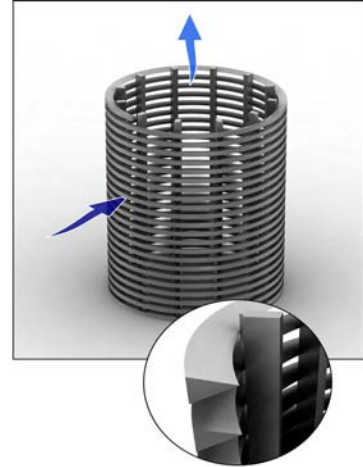

External Axial Wire (Re-Rolled)

External axial wire with internal circumferential support rods.

Benefit

- Facilitates cleaning with an external axial-movement scraper

Product

- Automatic filters

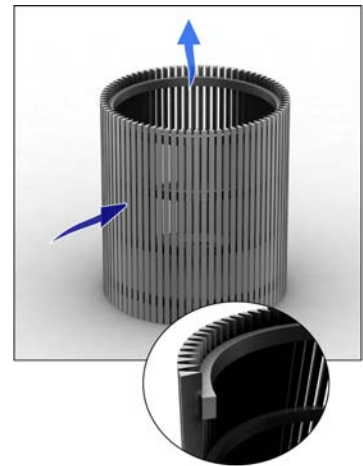

Channel Rod Construction

Perforated U-section channels replace the internal support rods. When the filter is used as a collector, flow is outside-in. When it is used as a distributor, flow is inside-out.

Benefit

- Optimized collection and distribution
- Replaces perforated inner tube

Application

- Potable water treatment
- Ion exchange
- Oil refining processes

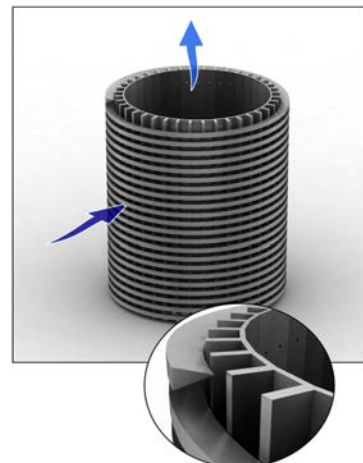

Cylindrical Screen for Inside to Outside Filtration Flow

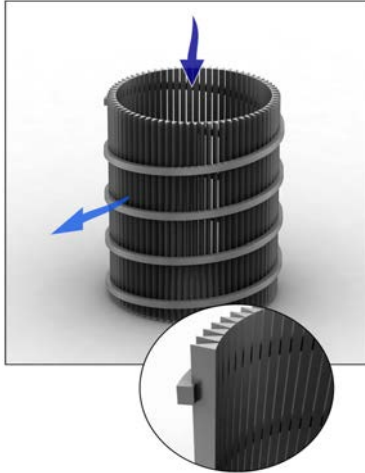

Internal Axial Wire (Wire-Based)

Internal axial wire with external circumferential support rods.

Benefit

- Smooth internal screen surface
- Facilitates cleaning with an internal axial-movement scraper
- The flow moves across the wire edges for effective dewatering

Product

- Trommel screens with internal feed
- Systems with an internal rotor or screw
- Dewatering systems
- Baskets
- Automatic filters

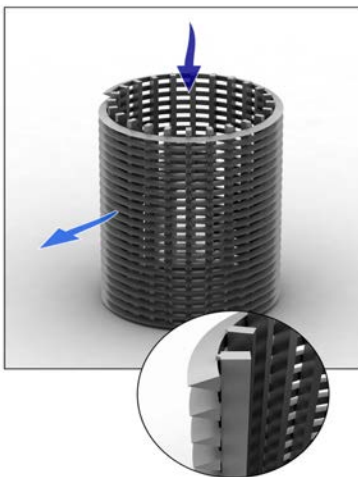

Inverted

External circumferential inverted wire and axial internal support rods.

Benefit

- Economical

Application

- Inside-out flow

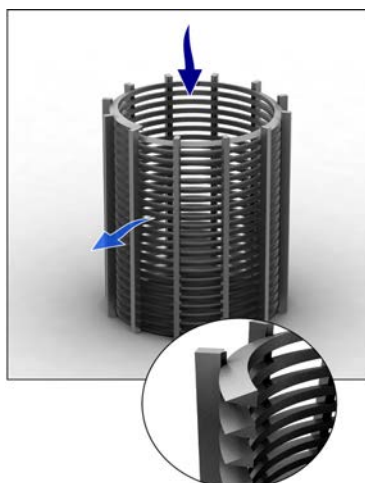

Internal Circumferential Wire (Re-Rolled)

Internal axial wire with external circumferential support rods.

Benefit

- Smooth internal screen surface
- Facilitates cleaning with an internal axial-movement scraper
- The flow moves across the wire edges for effective dewatering

Product

- Trommel screens with internal feed
- Systems with an internal rotor or screw
- Dewatering systems
- Baskets
- Automatic filters

Industrial Screening Products

Flat Screens

Johnson Screens offers a variety of flat screens for the malting and brewing industries. Vee-Wire screens are ideal for:

- Launder tubs
- Germination
- Kilning
- Ultra filtration
- Steeping
- Malt extraction

Used in the kilning, germination and drying phases of the malting process, Johnson Screens' malting bed screens are the ideal choice for malting floors and other screening needs in the malting process.

These screen panels can be designed to minimize "dead spots" in the malting floor over supports or other structures, to further improve the overall process. In between malting batches, the screens are very easy to clean, reducing contamination of the process



Candle Filters

Candle filters are filter elements with the following qualities:

- Small diameter usually less than 1.97 in. (50 mm)
- Substantial length usually greater than 39.37 in. (1,000 mm)
- Very fine openings: 25 to 150 microns, according to the application
- Direct filtration
- Medium support (diatoms in filters)

The filtration capacity can be easily modified by varying the number of candle filters to obtain the required filter area.

Cleaning

A stronger flow in the backward direction, known as backwash, cleans the candle filters effectively.

Maintenance

Because the filter elements are particularly rigid and rugged, they can be disassembled without risk of damage to the filter surface.



Support Grids

The support grid system is available in a variety of framing options and designs — as a one-piece construction or in multiple sections for onsite assembly and ease of retrofitting through existing manways.



Because of their strength, durability and flow characteristics, the support grids are widely used in hydrotreaters, desulfurizers, molecular sieves, gas sweeteners, ion exchangers and other absorption systems.

Features

- Slot size can be designed for direct media retention
- Grids can be supplied with support beams, rope packing, bolting and all necessary accessories

Benefits

- Self-supporting structure
- Exceptional resistance to collapsing or buckling, even in operations where screens must withstand extremely high loads
- More effective open area than grids using wire mesh or grating
- Smooth surface of the screens reduces abrasion of media



Cartridges and Outlet Baskets

A large range of industries use cartridges. Rugged, precise and easy to clean, these filter elements are suitable for all industrial processes.

They can be used for:

- Conventional filtration, outside-in
- Reverse filtration, inside-out

The use of extremely fine wire maximizes the open area. This process is even more effective for slots smaller than 100 microns.

The following types of fittings can be welded to allow incorporation of cartridges into any process:

- Collars
- Flanges
- BSP or NPT threaded end fittings
- Machined rings for fittings with O-rings or flat baskets
- Other fittings

Screen Lateral Systems

These assemblies consist of a series of screen laterals connected to either a central header pipe or a hub. They are designed for effective media retention in a wide range of applications, including ion exchangers, clay and sand filtration applications and carbon towers.

Features

- Lateral spacing, length, diameter and slot opening sizes are based on individual system need: slot size 0.002 in. (0.05 mm) and up in 0.0004 in. (0.01 mm) increments and diameter from 0.79 in. (20 mm) and up
- Assemblies are typically made with type 304SS, 316LSS or other exotic alloys are also available
- Connections of the laterals can be threaded fittings, couplings or flanges
- Optional internal drilled distributor pipe for a optimal backwash distribution cycle

Benefits

- The design allows a uniform collection or distribution flow of a gas or liquid through treatment media without dead zones
- The system can accommodate a wide variety of vessel sizes and shapes with side, center, top or bottom inlet piping
- The assemblies can be designed to accommodate flow in any direction



Laterals

There two types of Johnson Screens' laterals - without drilled pipe or with distributor pipe. Both types are very effective collectors, however, for most effective backwash distribution, the screen design should include an internal distributor pipe. These distributor pipes are sized by Johnson Screens' design engineers so that backwash is evenly distributed throughout the system.



Nozzles



Nozzles are used in liquid/solid or gas/solid separation. Their design and quantity will vary depending on application and customer-flow requirements. Nozzles allow a more effective use of the treatment media.

Common applications include:

- Collectors and distributors installed uniformly across a plate or a header lateral arrangement
- Demineralizers, water softeners and in pressure and gravity sand filters

Features

- Standard diameter: 1.96 in. (50 mm)
- Typical slot opening ranging from 0.007 in. to 0.019 in. (0.2 mm to 0.5 mm)
- Threaded end fittings or "L" bolts
- Primarily made of stainless steel; however, special spherical nozzles made from ABS or Kynar® are also available

Fractal Collectors and Distributors

Fractal collectors and distributors can be used in applications such as ion exchanges, resin beds and any chromatic process.



Features

- Lateral exit flow variation as little as 3 percent for the entire assembly
- Various options for sizes, shapes and flow capacities
- Distributors are typically made with type 304SS or 316LSS. Other alloys are also available

Benefits

- Equal contact time with media
- Equal residence time in the system
- Effective plug flow
- High distribution efficiency

Shaped Support Grid (SSG)

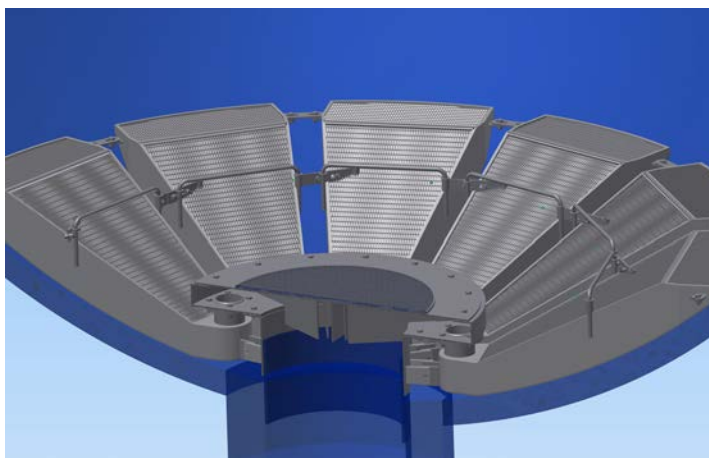

Johnson Screens' Shaped Support Grid (SSG) is designed to be installed into the bottom head of vessels, allowing for better liquid and gas flow, bed utilization, distribution and an overall more efficient process.

With traditional flat surface grids designs, the entire volume of the head is a dead area, with no reaction or drying adsorption occurring. The SSG lies directly on the bottom head surface, allowing for the entire volume to be filled with media. Increased bed volume allows for the conversion of existing vessels to achieve higher process capacity.

Resin Traps/Inline Strainer

A resin trap is a safety device used on the overflow lines of ion exchange units, high-purity water systems and activated carbon and media filters.

In many systems, a valve failure can allow media to escape from the treatment vessel. Not only is the loss of expensive media significant, but damage can easily occur to downstream pumping equipment.

Resin traps, placed inline, provide positive protection. The traps can be designed to capture media particles of any size

Features

- Continuous slot design, allowing traps to capture media particles of any size, providing sufficient open area to let process flow move smoothly
- Stainless steel construction (other alloys can be used, depending on pressure and temperature)
- Various options for sizes, shapes and connections, depending on process flow characteristics
- Designed for full system pressure

Benefits

- Prevents expensive resin/media loss into piping distribution system
- Protects downstream pumping equipment
- Visibility of minor resin/media losses in prevention of major equipment failure

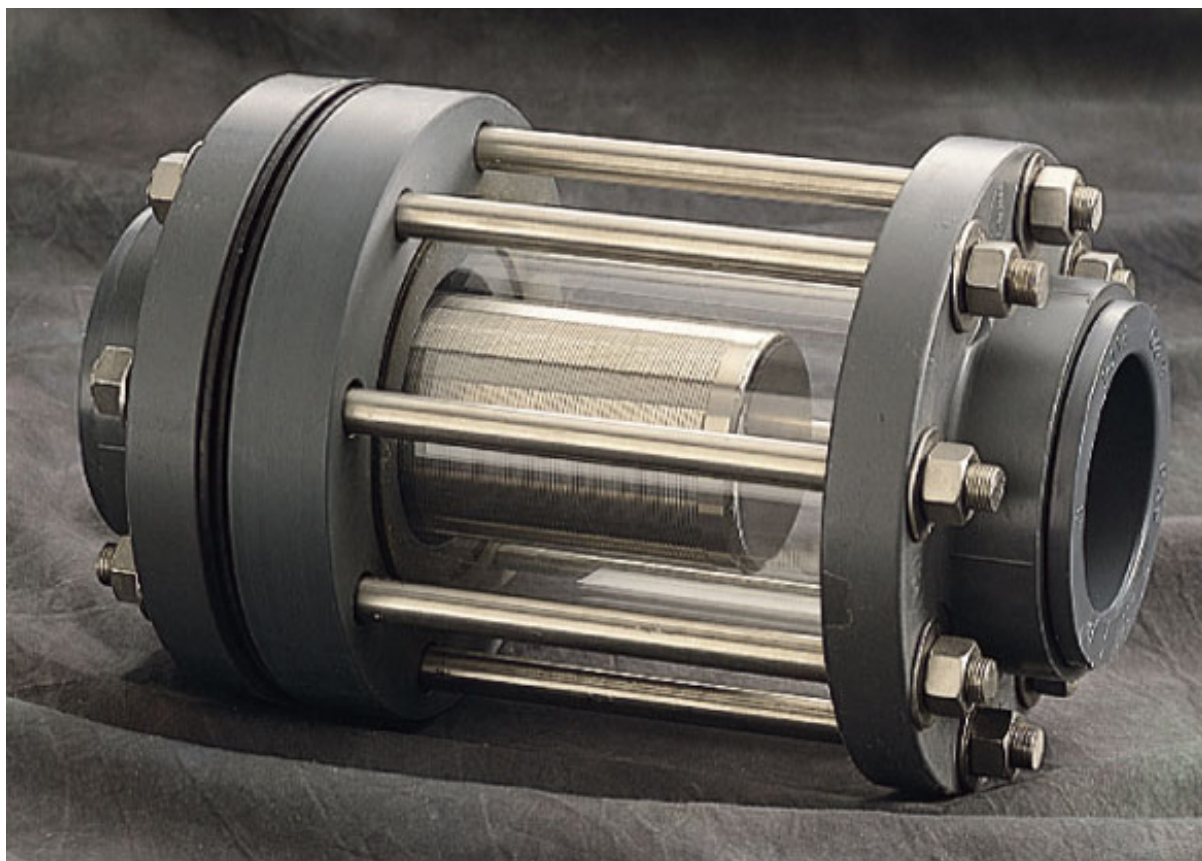

120° Sieve Bend Screen



Johnson Screens' 120° Sieve Bend Screen are used in static sieves for either dewatering or classification.

As the slurry flows over the inclined screen surface, the perpendicular layout of the wires to the flow, allows for solids to be retained while liquid passes through the screen.

Made from Vee-Wire screens, the 120° Sieve Bend Screen can provide up to 50 percent more open area with a narrower wire profile.

With a number of manual-handling restrictions, Johnson Screens has developed an innovative split-sieve design. This design offers a simple, economical benefit by reducing the physical size and the weight of the screen.

Features

- Reduced equipment and installation costs
- Low maintenance costs
- Better flow rate and finer fiber removal
- Wide range of applications
- Longer screen life
- Slot sizes range from 25 μm to 0.394 in. (10 mm)
- Made with 300 series stainless steel

Cylindrical Baskets



Cylindrical baskets can be designed for a flow from out to in (standard construction) or from in to out (re-rolled construction). These screens are adapted for self-cleaning filters or screw press filters and can be cleaned with static scrapers.

Features

- Dimensions adaptable to any specific needs
- Large range of constructions (wires, rods)
- All slot sizes from 25 μm
- Flanges and reinforcement rings available depending on the application

Benefits

- Self cleaning surface
- High open area
- Strong construction

Pressure Screens

Pressure screens are mainly used for the stock preparation in the pulp and paper industry. They can be used for any application involving fiber or fine grain filtration.

Features

- Specific, contoured wire shape
- Diameters from 7.87 in. to 59 in. (200 mm to 1,500 mm)
- Increased screening efficiency
- Special surface chroming process allows for less frequent cylinder replacement

Benefits

- The continuous slot gives a greater performance with a higher open area

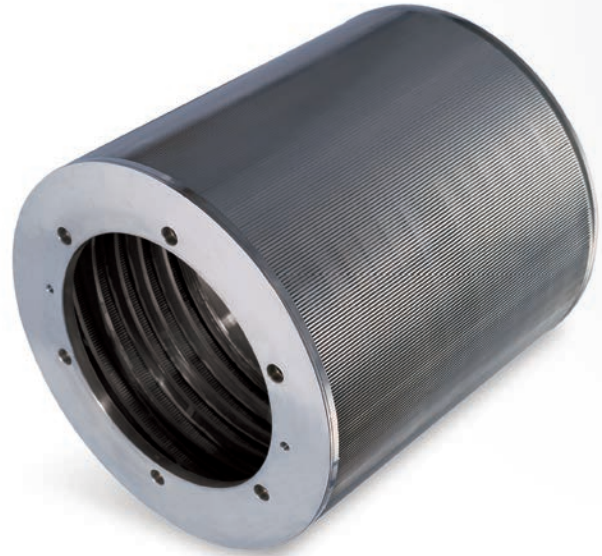

Screw Press Screens

For dewatering using a screw press, we can provide a screen designed to meet your exact specifications. Johnson Screens' high-strength design can withstand the rugged operation, while providing an accurate slot width and maximizing open area to maximize dewatering. For use in numerous industrial designs. Abrasion resistant options are available.

Features

- Accurate slot width
- Custom designed to fit any application

Benefits

- High strength design
- High open area



Centrifuge Baskets



Starch Processing

Johnson Screens' starch basket is designed to fit into any existing or new centrifuge application.

Vee-Wire Centrifuge Baskets improve starch refining by providing accurate and customized slot sizes that are specific to your needs.

Features

- Increased fiber dewatering compared to nickel screens
- Extended wear life
- Designed and manufactured to each centrifuge design
- Variable slot openings from 20 μm and up
- Fine Vee-Wire construction prevents clogging
- Capable of withstanding high backwash pressures

Sugar Processing

Johnson Screens' patented fine Vee-Wire continuous centrifuge basket has increased mechanical strength, a precise slot opening and a larger percentage of open area, increasing the amount of sugar crystal recovery.

The self-supporting structure of the basket is designed and engineered to withstand the high stresses and load conditions of the sugar industry.

Features

- Variable slot openings from 20 μm and up
- Long lasting, fewer change-outs
- High resistance to abrasion
- Fast and easy installation
- Low maintenance, easy to clean
- Replaces electroformed and laser screens

PVC Inline Mixer

Johnson Screens' NSF 61 approved inline mixer utilizes a unique internal design, which uses ordinary line pressure to create high levels of turbulence, enhancing the mixing of fluid additives with the product stream. With no moving parts, the inline mixer is virtually maintenance free and installs quickly and easily with no special tools or additional components. These inline mixers are used in a wide variety of processes, such as chemical blending, pH control, water treatment and chlorine mixing.

Standard features of the inline mixer include:

- PVC construction aids in chemical compatibility
- Clear PVC sight tube allows easy viewing of the mixing process
- Standard 1 in. male NPT threads on the inlet and outlet ports
- Standard ½ in. female NPT threads on the injection port
- Improved mixing performance
- Reduced energy consumption
- Larger wrench flats
- Reduced backpressure during operation
- Handles higher flow rates up to 30 GPM



PVC Vee-Wire

PVC Vee-Wire screens present higher open area than other PVC screens.

Pipe Size (in.)	Nominal O.D. (in.)	Dia. I.D. (in. ¹)	Weight/ft. (lbs.)	Tensile Strength (lbs) ²	Hang Weight (lbs.) ⁴	Open Area (sq in.) Per Foot of Screen Collapse Strength - PSI ³					
						Screen Slot Size (in.)					
						0.006	0.010	0.020	0.030	0.040	0.050
1 - 1/4 PS	1.7	1.2	0.7	780	195	3.1	4.9	9.2	12.8	16.0	18.9
						270	260	240	230	210	200
1 - 1/2 PS	1.9	1.5	0.8	1200	310	3.4	5.5	10.2	14.3	17.9	21.1
						180	180	160	150	140	130
2P/3T	2.4	1.9	0.8	1300	330	4.3	7.0	12.9	18.1	22.6	26.6
						95	92	85	79	74	70
2 PS*	2.6	2.0	0.9	1300	330	4.7	7.5	14.0	19.6	24.5	28.8
						72	70	65	61	57	54
3 PS	3.5	2.9	1.5	1800	460	5.4	8.8	16.5	23.3	29.3	34.7
						170	160	150	150	140	130
4 Special	4.5	3.9	1.7	2100	530	7.0	11.3	21.2	29.9	37.7	44.6
						81	78	74	69	65	62
4 PS*	4.6	4.0	1.8	2100	530	7.1	11.6	21.7	30.6	38.5	45.6
						75	73	68	64	60	57
5 PS	5.7	4.9	2.5	3900	980	8.3	13.4	25.3	35.8	45.2	53.7
						73	72	68	65	62	59
6 PS	6.6	5.9	3.7	4600	1200	8.0	13.1	24.9	35.5	45.2	54.1
						73	72	68	65	62	59
8 PS	8.8	7.6	4.6	5500	1400	13.6	22.1	41.5	58.6	73.7	87.3
						60	59	55	52	49	46

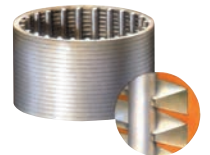

Designs up to 6 in. are made with standard rod base.

1. Clear ID's are minimum inside diameters
2. Tensile values are based on support rod area, other values are based on flush-thread test values
3. Collapse strengths are calculated values - no safety factor included
4. Hang weights are the maximum combined weight of riser and screen to be hung from the top screen joint
5. All strength properties are based on 73° F
6. Alternate construction for environmental applications

*Alternate construction for environmental applications

Loop Profile Wire Screens

Loop Profile wire screens find uses in a wide variety of applications. Loop construction eliminates a welding requirement to join the rod and wire, and greatly increases the strength and durability of the screen.

Johnson Screens' proprietary loop wire manufacturing process allows for a great degree of flexibility in producing various profile shapes, openings and support member

configurations. Standard specifications for Loop Profile wire screens are illustrated. Additional specifications are available by contacting your Wedge Wire sales engineers.

Flexible manufacturing gives Wedge Wire the capability to manufacture screens utilizing virtually any metal, from basic carbon steels to high tech alloys.

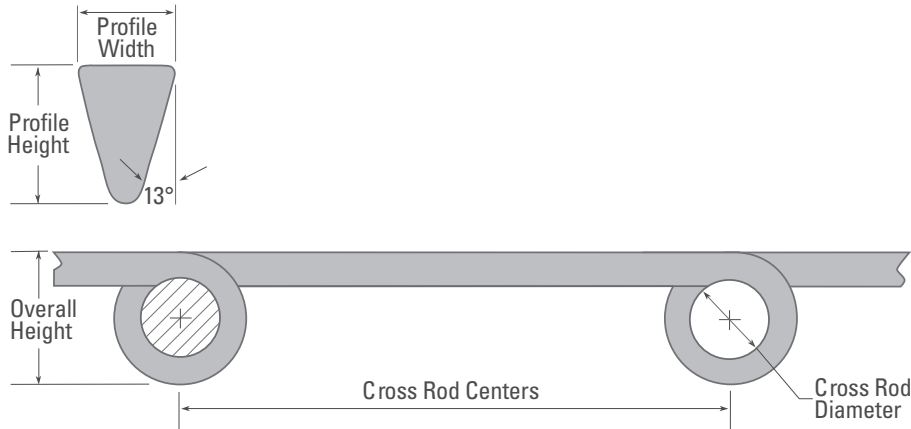

Specifications for Profile "D"

Wire Number	Standard Openings (in.)	Cross Rod Diameter (in.)	Cross Rod Centers (in.)	Profile*	
				Width (in.)	Height (in.)
70	.003 - .040	0.25	2	0.06	0.085
100	.005 - .060	0.3125, 0.375	2.75	0.086	0.125
132	.010 - .080	0.3125, 0.375, 0.5	2.75	0.109	0.156
156	.020 - .100	0.375, 0.5	2.75	0.135	0.188
187	.030 - .120	0.375, 0.5	2.75	0.172	0.219
217	.040 - .160	0.375, 0.5	2.75, 4	0.188	0.266
250	.060 - .200	0.5	2.75, 4	0.219	0.281

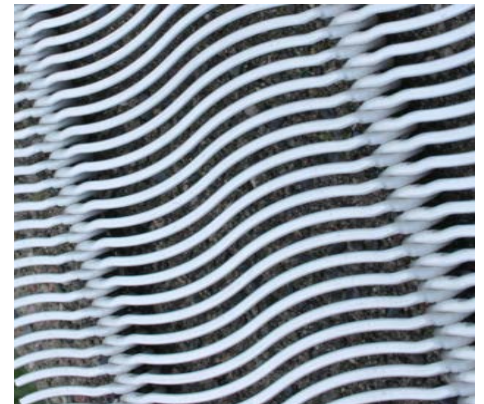

Specifications for Profile "WT"

Wire Number	Standard Openings (in.)	Cross Rod Diameter (in.)	Cross Rod Centers (in.)	Profile*	
				Width (in.)	Height
156	.020 - .100	0.375, 0.5	2.75	0.125	0.188
187	.030 - .120	0.375, 0.5	2.75	0.156	0.219
217	.040 - .160	0.375, 0.5	2.75, 4	0.188	0.25
250	.060 - .200	0.5	2.75, 4	0.219	0.131

*Dimensions are based upon a specified opening.

Larger openings can be obtained for each respective wire size by the use of spacers between each wire.

Looped Wire Assembly and Framing Options

Comprehensive fabrication capabilities allow Johnson Screens to supply a wide range of customized framing and assembly options designed to meet individual customer needs.

Johnson Screens' technical department and engineering staff are available to help create the total profile wire system which is best suited to solve your specific application requirements.

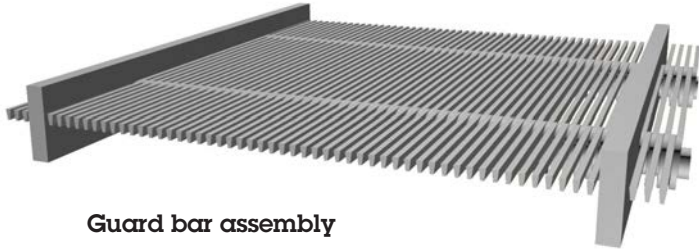

Guard bar assembly

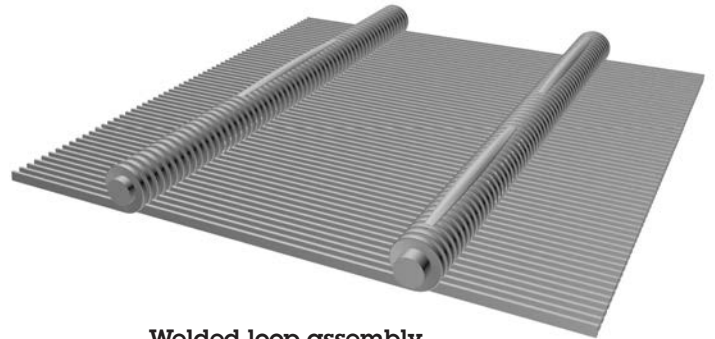

Welded loop assembly

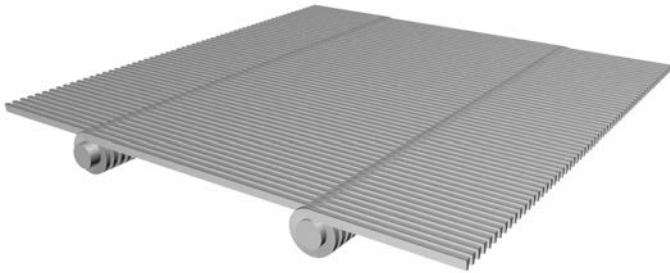

Mat section with no bushing

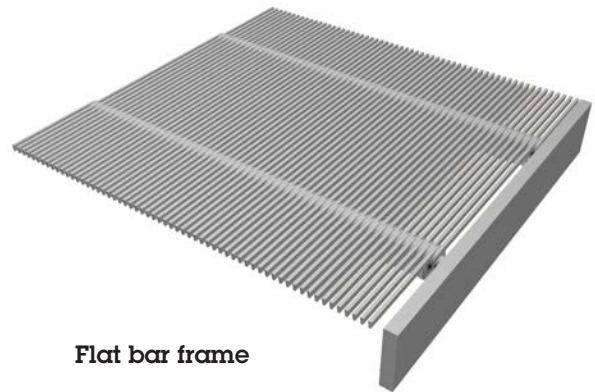

Flat bar frame

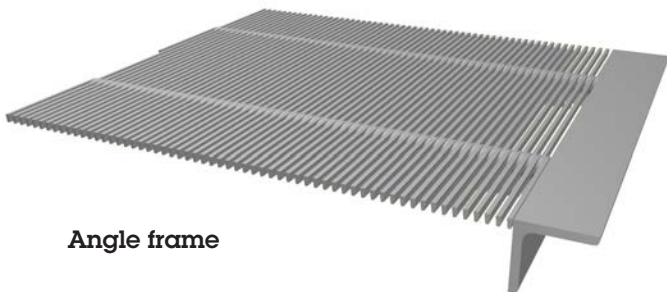

Angle frame

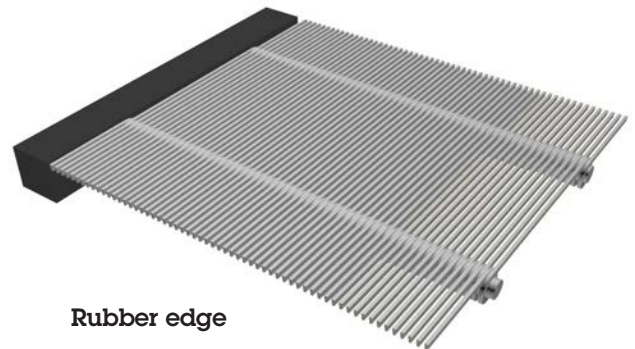

Rubber edge

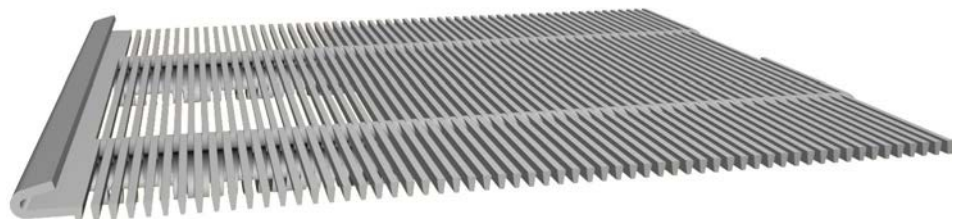

Hook Strip



Diamond Top

The "diamond" configuration of this profile wire surface acts to guide liquids toward openings and substantially increases screening efficiency. This action also agitates particles which helps in the prevention of material adhesion.

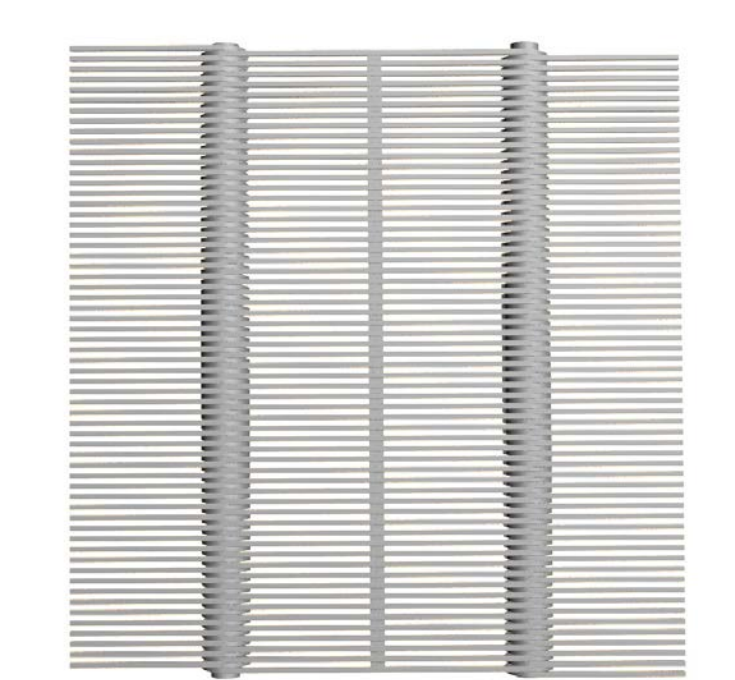

Blips

In severe screening applications, spacing blips can be placed in the profile wire between standard cross support rod loops. The spacing blips insure accurate and uniform slot openings during operation.

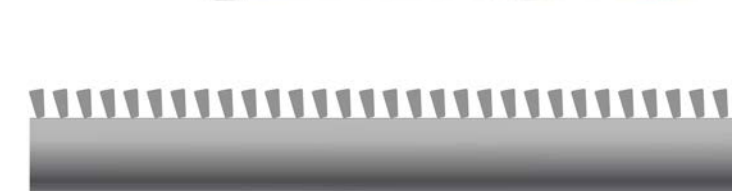

Tilt

The "tilting" of the profile wire angle, typically 5° to 10°, enhances the dewatering and separation of material on cross flow screening applications

Free-Flow

Free-Flow screens are made with a ribbon lock-bar process. This process incorporates cross-bars which are inserted into slotted longitudinal profile bars, rotated 90° and locked into place. The cross bars are then automatically welded on the underside only.

Free-Flow screens are typically used in high wear applications requiring a clear, free slotted screen surface. Free-Flow is available in openings of .010" and larger with total stainless steel construction.

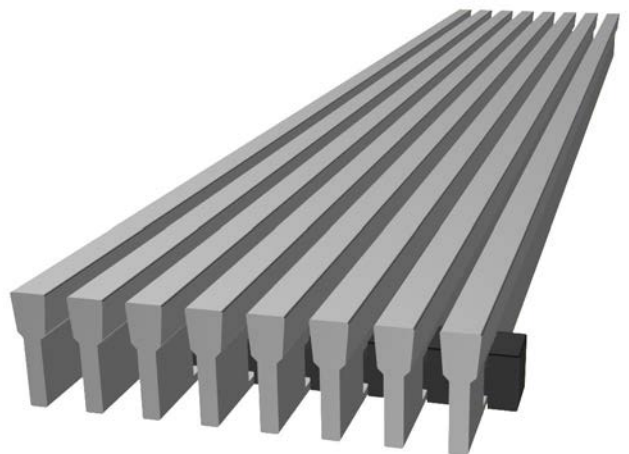

Wire and Rod Information

Vee-Wire® Profiles - Most Commonly Used

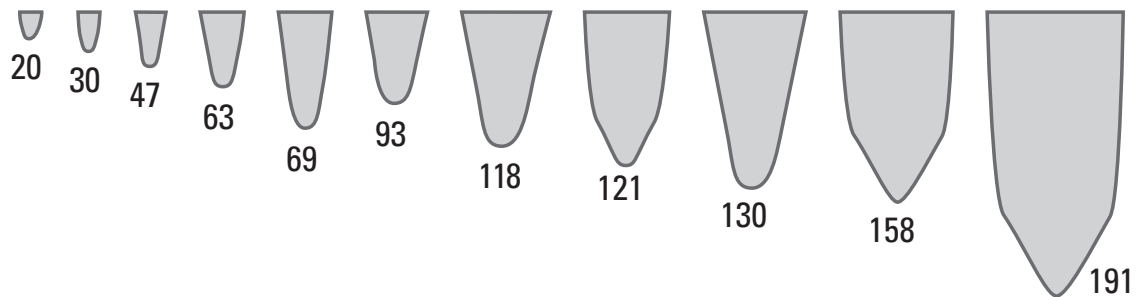

$$\text{Open Area (\%)} = \frac{\text{Slot Size} \times 100}{\text{Slot Size} + \text{Wire Width}}$$

Name	Width		Height		Section Area		Relief Angle
	in.	mm	in.	mm	in ²	mm ²	
20	0.020	0.508	0.040	1.016	0.0005	0.323	11°
30	0.030	0.762	0.050	1.270	0.001	0.645	13°
47	0.047	1.194	0.088	2.235	0.003	1.935	10°
63	0.060	1.524	0.100	2.540	0.004	2.581	13°
69	0.071	1.803	0.177	4.496	0.010	6.452	7°
93	0.089	2.261	0.138	3.505	0.009	5.806	13°
118	0.116	2.946	0.185	4.699	0.015	9.677	13°
130	0.130	3.302	0.250	6.350	0.023	14.839	8°
191	0.195	4.953	0.363	9.220	0.055	35.484	5°

Shaped Support Rods

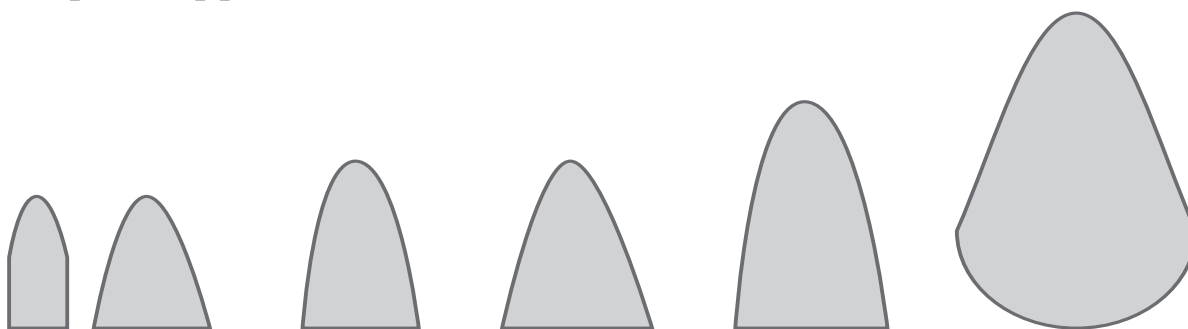

Name	Width		Height		Section Area		Section Modulus (in. ³ x 10 ⁻³)
	in.	mm	in.	mm	in.	mm	
29	0.029	0.737	0.102	2.591	0.003	0.076	0.037
63	0.060	1.524	0.100	2.540	0.004	2.581	0.050
93	0.089	2.261	0.138	3.505	0.009	5.806	0.150
XJR	0.089	2.261	0.189	4.801	0.013	0.330	0.298
60SR	0.060	1.524	0.120	3.048	0.006	0.152	0.077
156	0.151	3.835	0.217	5.512	0.022	0.559	0.600

Tri-Wire Profiles

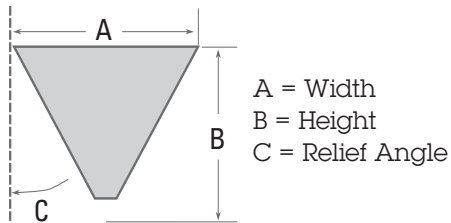

Wire Number	Width		Height		Relief Angle
	in.	mm	in.	mm	
93 TRI	0.093	2.388	0.070	1.956	30°
125 TRI	0.125	3.175	0.094	2.769	30°
188 TRI	0.188	4.775	0.141	4.369	30°
250 TRI	0.25	6.35	0.188	5.563	30°
500 TRI	0.50	12.7	0.469	11.913	30°

Examples of Screen Open Area

Wire No.	Percent of Open Area						Slot Opening Size (in.)
	20	30	40	50	60	70	
30	0.008	0.013	0.020	0.030	0.045	0.070	
47	0.012	0.020	0.031	0.047	0.071	0.110	
63	0.015	0.026	0.041	0.060	0.090	0.140	
69	0.018	0.030	0.047	0.071	0.107	0.166	
93	0.022	0.038	0.059	0.089	0.134	0.208	
118	0.029	0.050	0.077	0.116	0.174	0.271	
130	0.033	0.056	0.087	0.130	0.195	0.303	
158	0.040	0.068	0.105	0.158	0.237	0.369	
191	0.049	0.084	0.130	0.195	0.293	0.455	
250 TRI	0.063	0.107	0.167	0.250	0.375	0.583	
500 TRI	0.125	0.214	0.333	0.500	0.750	1.167	

Standard Welded Construction

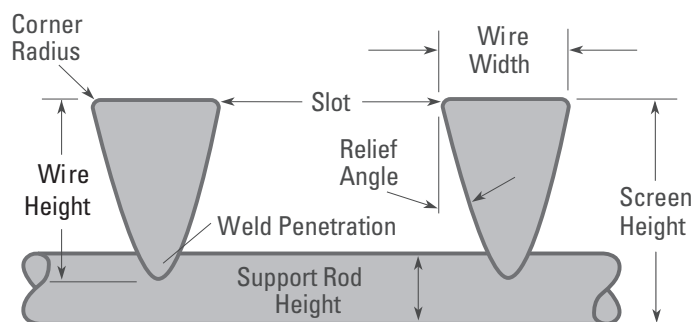

Round and Strip Rods

- Round rods are available in diameters ranging from 0.125 to 0.500 in. (3.175 to 12.7 mm).
- Strip rods are available in widths ranging from 0.070 to 0.188 in. (1.778 to 4.775 mm) and heights ranging from 0.375 to 2.0 in. (9.525 to 50.8 mm).

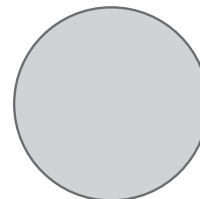

Aqseptence Group, Inc.
Industrial & Architectural Screens

North America
Phone +1 651 636 3900
Fax +1 651 638 3171
info.johnsonscreens.us@aqseptence.com

Australia - Asia Pacific
Phone +61 7 3867 5555
Fax +61 7 3867 5566
info.johnsonscreens.au@aqseptence.com

Europe
Phone +33 5 49021600
Fax +33 5 49021616
info.johnsonscreens.fr@aqseptence.com

India
Phone +91 2764 281007 / 281220 / 281221
Fax +91 2764 281028
info.johnsonscreens.in@aqseptence.com

Japan
Phone +81 45 661 3575
Fax +81 45 661 1921
info.johnsonscreens.jp@aqseptence.com

Argentina
Phone +54 11 4714 6699
Fax +54 11 4714 2175
info.johnsonscreens.ar@aqseptence.com

Brazil
Phone +55 11 4341-5777
Fax +55 11 4393-0414
info.johnsonscreens.br@aqseptence.com

Chile
Phone +56 02 9280700
Fax +56 02 9280705
info.johnsonscreens.cl@aqseptence.com

www.aqseptence.com