



**Johnson
Screens**



Food and Beverage Processing

Comprehensive solutions for Bio-Fuels, Brewing, Corn Wet Milling, Ethanol, Malting, Starch, Sugar Treatment and Wine Production

A brand of
Aqseptence Group

Food and Beverage Processing Capabilities



Innovative Design

Johnson Screens produces stainless steel Vee-Wire® filter elements for liquid/solid and gas/solid separation that is known for great strength, a long service life and a high level of adaptability.

Vee-Wire screens are made by welding our patented V shaped wire onto various sizes and shapes of support rods. This process creates a slot that enlarges inwardly, creating a large open area and clog-resistant surface. Our continuous welding method meets the most demanding standards for ruggedness, durability, resistance to abrasion, consistency and slot openings.

Vee-Wire is used in industries such as:

- Bio-fuels
- Brewing
- Corn wet milling
- Ethanol
- Malting
- Starch
- Sugar processing
- Wine production
- Meat processing
- Salt processing



Quality

Johnson Screens has been delivering reliable screens to various industries for more than a century; and though technology has changed, our commitment to quality products and services has not.

As a ISO-certified company, each product is subject to a procedure of self-inspection by each operator throughout the manufacturing process. A final inspection guarantees delivery of a product that fully meets the user's technical specifications.

Johnson Screens can provide the following documents upon request:

- Quality plan
- Manufacturing plan
- Production schedule
- Welder performance qualification
- Welding procedure specification (WPS)
- Procedure qualification record (PQR)
- In-house inspection reports
- Chemical and/or mechanical analysis certificates



OEM Collaboration

- Aid in design
- Add value to equipment offerings
- After market support



Custom designed and engineered

Each project is designed to ensure complete satisfaction. We provide guidance and support from project conception to completion.

Longer lasting

Johnson Screens' manufacturing standards are the most stringent in the industry. Featuring the patented Vee-Wire technology, the screens are extremely durable and have high resistance to abrasion, corrosion and impact damage.

Lower maintenance

The rugged construction and high quality of the materials produce a product that lasts longer and requires less maintenance.

Less costly

Superior operating efficiency, reduced maintenance needs, and extended service life combine to decrease the cost of ownership of Johnson's screens to plant operators.

Many construction options

Johnson's screen surfaces can be used:

- For direct screening
- As filter media support (sand bed, activated carbon, resins, catalysts)
- Pre-coat vacuum filters

Screens are available in slot opening from 0.001 in. (25 μ m) up to 1 in. (25 mm). Most common materials used are 300 series stainless steel, but many exotic alloys are available to suit specific applications.

Johnson's screens are available in a variety of shapes to suit customer needs:

- Cylinders
- Flat or curved panels
- Cones
- Any form specific to a given application.

The flexibility of the process allows the manufacture of custom made screens for all types of applications: new plant, expansions or upgrades.

Cylindrical Screens for Outside to Inside Filtration Flow

Standard

External circumferential wire and axial internal support rods.

Benefit

- Economical
- Suitable for most applications
- Precision openings

Product

- Filter cartridges
- Candle filters
- Header laterals
- Rotating drum screens
- Nozzles
- Resin traps

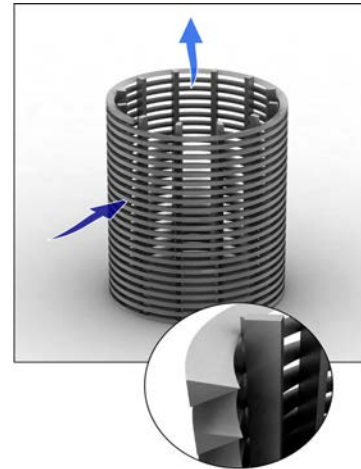

External Axial Wire (Re-Rolled)

External axial wire with internal circumferential support rods.

Benefit

- Facilitates cleaning with an external axial-movement scraper

Product

- Automatic filters

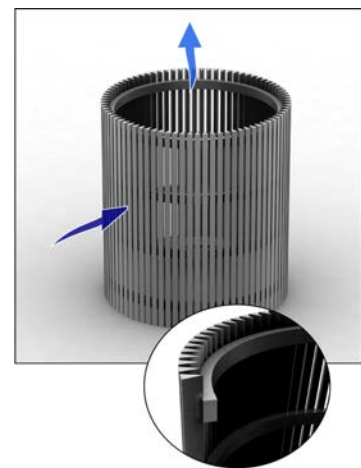

Channel Rod Construction

Perforated U-section channels replace the internal support rods. When the filter is used as a collector, flow is outside-in. When it is used as a distributor, flow is inside-out.

Benefit

- Optimized collection and distribution
- Replaces perforated inner tube

Application

- Potable water treatment
- Ion exchange
- Oil refining processes

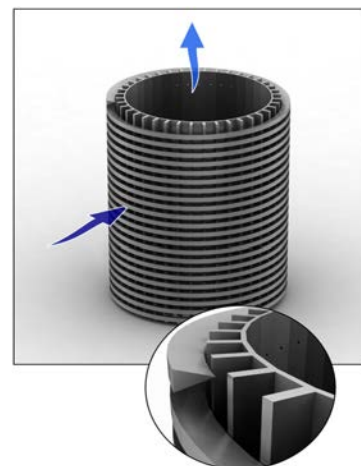

Cylindrical Screen for Inside to Outside Filtration Flow

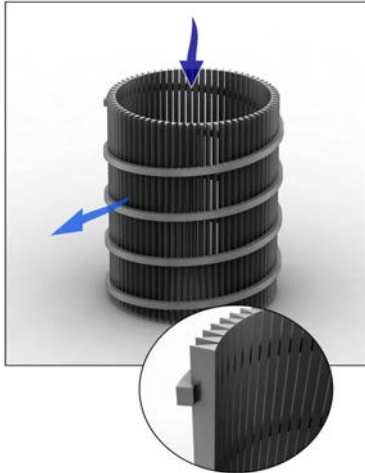

Internal Axial Wire (Wire-Based)

Internal axial wire with external circumferential support rods.

Benefit

- Smooth internal screen surface
- Facilitates cleaning with an internal axial-movement scraper
- The flow moves across the wire edges for effective dewatering

Product

- Trommel screens with internal feed
- Systems with an internal rotor or screw
- Dewatering systems
- Baskets
- Automatic filters

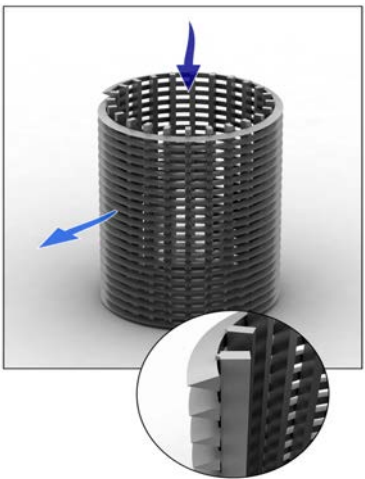

Inverted

External circumferential inverted wire and axial internal support rods.

Benefit

- Economical

Application

- Inside-out flow

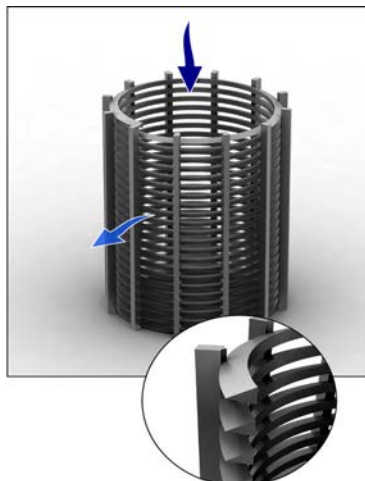

Internal Circumferential Wire (Re-Rolled)

Internal axial wire with external circumferential support rods.

Benefit

- Smooth internal screen surface
- Facilitates cleaning with an internal axial-movement scraper
- The flow moves across the wire edges for effective dewatering

Product

- Trommel screens with internal feed
- Systems with an internal rotor or screw
- Dewatering systems
- Baskets
- Automatic filters

Corn Milling

120° Sieve Bend Screen

Made from Vee-Wire screens, the 120° Sieve Bend Screen can provide up to 50 percent more open area with a narrower wire profile.

Features

- Reduced equipment and installation costs
- Low maintenance costs
- Better flow rate and finer fiber removal
- Wide range of applications
- Longer screen life
- Slot sizes range from 20 μm to 0.394 in. (10 mm)
- Made with 300 series stainless steel

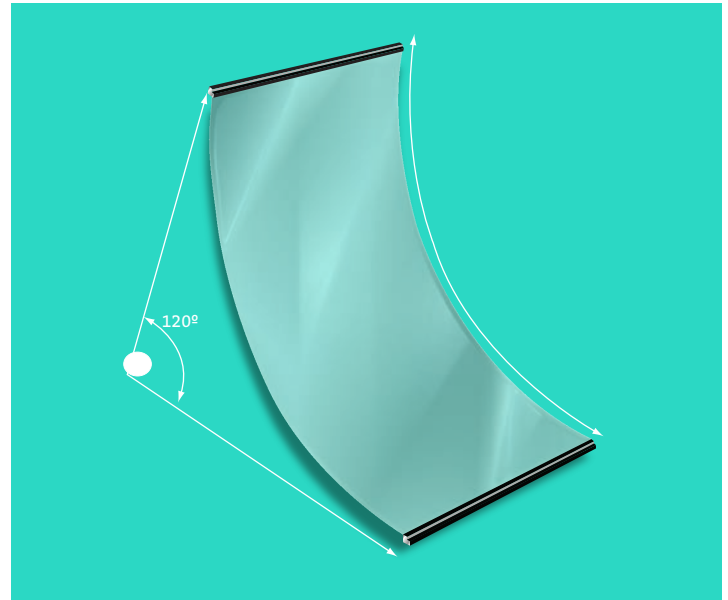

One Piece Paddle Screens

Used traditionally in the corn wet milling industry for fine fiber removal, Johnson Screens' paddle screen is custom engineered to fit any centrifugal design.

Benefits

- Custom, consistent slot size
- Fine particle screening
- Long lasting, durable
- Made from 304 and 316 stainless steel (other materials available on request)



Loop Profile Wire Screens

Loop construction eliminates a welding requirement to join the rod and wire, and greatly increases the strength and durability of the screen. Loop Profile Wire is used primarily in gravity sieve applications.

Our proprietary loop wire manufacturing process allows for a great degree of flexibility in producing various profile shapes, openings and support member configurations.

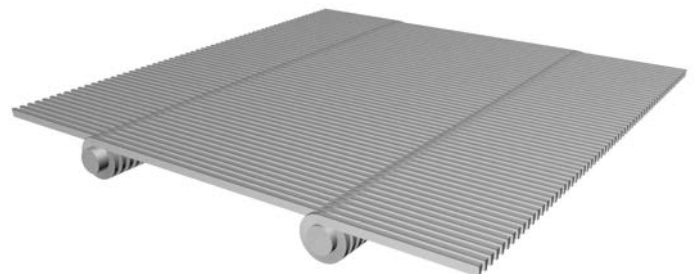



Nozzles

Johnson Screens' nozzle line enables more effective use of the treatment media.

Features include:

- Increased strength and corrosion resistance
- Available in stainless steel, ABS and Kynar®
- Standard diameter of 1.97 in. (50 mm) standard slot opening of 0.007 in. (0.18 mm) for stainless steel
- Standard slot opening of 0.008 in. (0.2 mm) for ABS and Kynar nozzles
- Threaded end fittings or hold down bolts

Screen Lateral Systems

Assemblies consist of a series of screen laterals that are connected to either a central header pipe or a hub and are designed for effective media retention in a wide range of applications.

Features

- Uniform collection or distribution flow
- Designed to accommodate flow in any direction
- Slot sizes from 0.002 in. (0.05 mm) and up
- Diameters from 0.787 in. (20 mm) and up
- Typically made from 300 series stainless steel
- Connections of the laterals can be threaded fittings, couplings or flanges

Fractal Collectors and Distributors

These advanced screen assemblies allow better use of the media and an increase in overall process efficiency.

Features

- Lateral exit flow variation as little as 3 percent for the entire assembly
- Various options for sizes, shapes and flow capacities available
- Distributors are typically made with type 304SS or 316LSS. Other alloys are also available

Benefits

- Equal contact time with media
- Equal residence time in the system
- Effective plug flow
- High distribution efficiency

Sugar Processing

Sugar Processing

Johnson Screens' patented fine Vee-Wire Continuous Centrifuge Basket has increased mechanical strength, a precise slot opening and a larger percentage of open area, increasing the amount of sugar crystal recovery.

The self-supporting structure of the basket is designed and engineered to withstand the high stresses and load conditions of the sugar industry.

Features

- Variable slot openings from 20 μm and up
- Long lasting, fewer change-outs
- High resistance to abrasion
- Fast and easy installation
- Low maintenance, easy to clean
- Replaces electroformed and laser screens



Sugar Beet Tower Screens

Ideal for use in cossette mixers and extraction towers, these screens are typically constructed out of looped wire construction, though Vee-Wire construction is also available.

- High open area lends resistance to clogging
- Strong resistance against abrasion
- Customized slot sizes
- Fine wires available

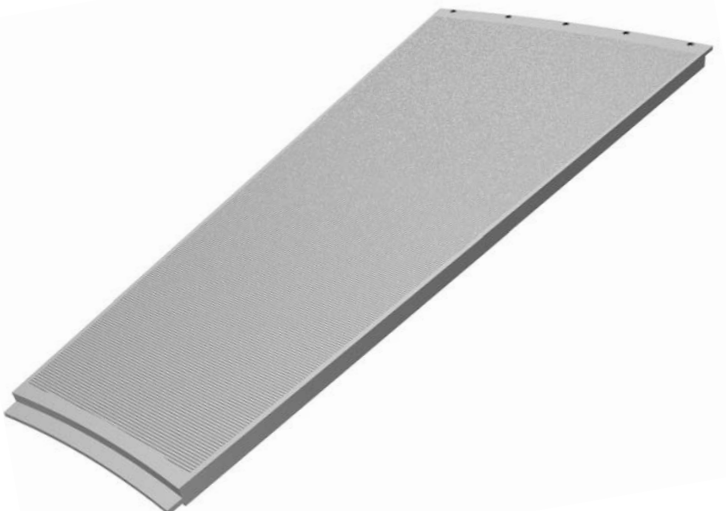



Gravity Screens

Johnson Screens' gravity screen is used for coarse separations ahead of additional processing systems.

Gravity screens use a Vee-Wire dewatering screen to retain the solids while allowing effluent to run through the system. The slurry is gravity fed to the head box and then flows to the screen. The solids retained from the screen are gathered for disposal or reuse.

The easy-to-install gravity screen features low operating and maintenance costs and can be designed according to client specifications.



Rotary Sieves and Screens

Johnson Screens' Rotary Sieve allows for large flows to be pumped over the Vee-Wire sieve screen inside, which separates the liquids and solids as the system rotates. The slurry is pumped into the rotary sieve, and the liquid and smaller solids pass through the slots in the screen. Larger solids travel down the length of the screen to the discharge end.

Rotary Sieves can be manufactured in either 304 or 316 stainless steel, and come in any size diameter and length. The screens inside the rotary sieve are especially designed to fit the specifications of each rotary sieve and are available separately from the rotary sieve itself. They are ideal for replacing worn out screens in existing applications. Based on the screening needs, the slot and wire sizes can be individualized to each process.

OEM Screens

Candle Filters

The filtration capacity can be modified easily by varying the number of candle filters to obtain the required filter area.

Vee-Wire candle filters are used widely in the brewing industry for filtration. Housed inside a cylindrical vessel, the filtration capacity can be modified easily by varying the number of candle filters to obtain the required filter area.

Features

- Small diameter usually less than 1.97 in. (50 mm)
- Substantial length usually greater than 39.37 in. (1,000 mm)
- Very fine openings: 25 to 150 microns, according to the application
- Direct filtration
- Medium support (diatoms in filters)

The filtration capacity can be easily modified by varying the number of candle filters to obtain the required filter area



Rotary Screens and Press Screens

Johnson Screens' gravity screen is used for coarse separations ahead of additional processing systems.

Gravity screens uses a Vee-Wire dewatering screen to retain the solids while allowing effluent to run through the system. The slurry is gravity fed to the head box and then flows to the screen. The solids retained from the screen are gathered for disposal or reuse.

The easy-to-install gravity screen features low operating and maintenance costs and can be designed according to client specifications.



Salt Processing



Vacuum Evaporation

Johnson Screens' fine wire capability allows for the production of vacuum wheel screens that can dewater the salt and increase the useful life of a screen from months to years. The mechanical strength and design of Johnson Screens fine wire screens are integral to avoid costly down time and screen replacements.

Fine wire screens are available in a variety of materials: Stainless Steels, Hastelloy, Inconel, Super Duplex and other exotic materials are available upon request.

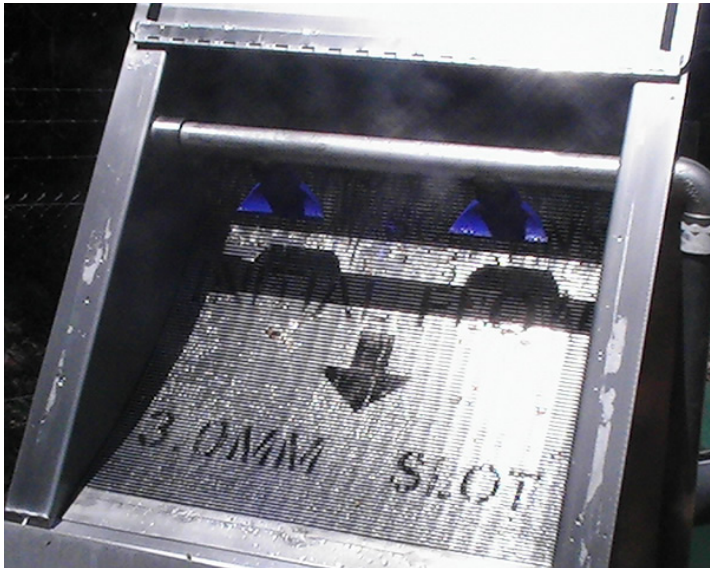

Sea Salt Evaporation

Johnson Screens' gravity screen is used for coarse separations ahead of additional processing systems.

Gravity Screens uses a Vee-Wire dewatering screen to retain the solids while allowing effluent to run through the system. The slurry is gravity fed to the head box and then flows to the screen. The solids retained from the screen are gathered for disposal or reuse.

The easy-to-install gravity screen features low operating and maintenance costs and can be designed according to client specifications.



Rotary Sieves and Screens

Johnson Screens' Rotary Sieve allows for large flows to be pumped over the Vee-Wire sieve screen inside, which separates the liquids and solids as the system rotates. The slurry is pumped into the rotary sieve, and the liquid and smaller solids pass through the slots in the screen. Larger solids travel down the length of the screen to the discharge end.

Rotary Sieves can be manufactured in either 304 or 316 stainless steel, and come in any size diameter and length. The screens inside the rotary sieve are especially designed to fit the specifications of each rotary sieve and are available separately from the rotary sieve itself. They are ideal for replacing worn out screens in existing applications. Based on the screening needs, the slot and wire sizes can be individualized to each process.

Brewing and Wineries

Candle Filters

The filtration capacity can be modified easily by varying the number of candle filters to obtain the required filter area.

Vee-Wire candle filters are used widely in the brewing industry for filtration. Housed inside a cylindrical vessel, the filtration capacity can be modified easily by varying the number of candle filters to obtain the required filter area.

Features

- Small diameter usually less than 1.97 in. (50 mm)
- Substantial length usually greater than 39.37 in. (1,000 mm)
- Very fine openings: 25 to 150 microns, according to the application
- Direct filtration
- Medium support (diatoms in filters)

The filtration capacity can be easily modified by varying the number of candle filters to obtain the required filter area



Nozzles

The Johnson Screens nozzle line enables more effective use of the treatment media.

Features include:

- Increased strength and corrosion resistance
- Available in stainless steel, ABS and Kynar®
- Standard diameter of 1.97 in. (50 mm) standard slot opening of 0.007 in. (0.18 mm) for stainless steel
- Standard slot opening of 0.008 in. (0.2 mm) for ABS and Kynar nozzles
- Threaded end fittings or hold down bolts



Screen Lateral Systems

Assemblies consist of a series of screen laterals that are connected to either a central header pipe or a hub and are designed for effective media retention in a wide range of applications.

Features

- Uniform collection or distribution flow
- Designed to accommodate flow in any direction
- Slot sizes from 0.002 in. (0.05 mm) and up
- Diameters from 0.787 in. (20 mm) and up
- Typically made from 300 series stainless steel
- Connections of the laterals can be threaded fittings, couplings or flanges

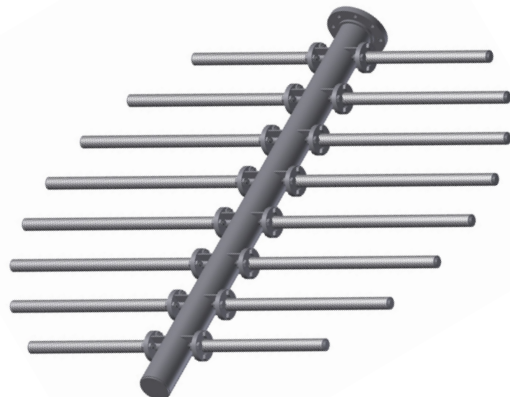

Vegetable, Meat and Seafood Processing



Rotary Sieves and Screens

Johnson Screens' Rotary Sieve allows for large flows to be pumped over the Vee-Wire sieve screen inside, which separates the liquids and solids as the system rotates. The slurry is pumped into the rotary sieve, and the liquid and smaller solids pass through the slots in the screen. Larger solids travel down the length of the screen to the discharge end.

Rotary Sieves can be manufactured in either 304 or 316 stainless steel, and come in any size diameter and length. The screens inside the rotary sieve are especially designed to fit the specifications of each rotary sieve and are available separately from the rotary sieve itself. They are ideal for replacing worn out screens in existing applications. Based on the screening needs, the slot and wire sizes can be individualized to each process.

Support Grids

Johnson Screens' support grid system is available in an assortment of framing options and designs; as one-piece construction or in multiple sections for on-site assembly.



Features

- Self-supporting structure
- Engineered to meet design load requirements
- Larger open area, compared to wire mesh and perforated plate
- Smooth surface, reducing abrasion of media
- Variable slot size depending on media retention needs
- Grids can be supplied with support beams, rope packing, bolting and all necessary accessories
- Hold down bolts

Gravity Screens

Johnson Screens' gravity screen is used for coarse separations ahead of additional processing systems.

Gravity screens use a Vee-Wire dewatering screen to retain the solids while allowing effluent to run through the system. The slurry is gravity fed to the head box and then flows to the screen. The solids retained from the screen are gathered for disposal or reuse.

The easy-to-install gravity screen features low operating and maintenance costs and can be designed according to client specifications.



Water Intake and Treatment Systems

Passive Intake Screens

Johnson Screens' Passive Intake Screens are designed to protect the natural surroundings and aquatic life near the intake.

Available with a Hydroburst® cleaning system, the passive intake screen is designed to reduce slot entrance velocity to 0.5 ft/s (0.135 m/s). This lower velocity helps to prevent debris clogging.

Johnson Screens' intake system offers many benefits including:

- Low cost
- Limited maintenance
- Environmentally friendly
- Easy cleaning
- No disposal of debris



Triton Underdrain System

Johnson Screens' Triton underdrains utilizes Vee-Wire technology, creating a low profile underdrain system with direct media retention, while maintaining a high open area with non-plugging characteristics.

Available in stainless steel and PVC, Triton underdrains are easily adapted to existing systems, increasing the efficiency of older systems.



Other Water Equipment and Solutions

Aqseptence Group offers a full range of equipment for multiple water process applications which require the separation, removal and treatment of the solids from the liquid flows.

Please visit www.aqseptence.com to learn more about our brands, capabilities and to contact our staff to find how we can assist you.



Exceptional Products, Exceptional Service



Field Service

Johnson Screens offers a complete field service team of specialized and experienced members that are available for various projects including:

- Full installation
- On-site repairs
- Technical assistance or expertise
- Work supervision
- Inspection

Flexibility and expertise allow us to propose this extended scope of services under tailor-made contract conditions in order to better serve our clients' requirements.

Our experienced welder/fabricators team is available for on site installation, repairs and screen replacement, and can be available within 24 hours for emergency situations or scheduled as needed.

The ability to evaluate the condition of screens and make recommendations as to the best course of action, our field service team will be there to allow the screens to operate at maximum capacity.

Whether cleaning, making minor or major repairs, or completely replacing screens, our technicians are equipped with all the tools, equipment and experience needed to provide the best field service available.

Our experienced technicians are also available for supervision of installations and on-site repairs.

Looped Wire Assembly and Framing Options

Comprehensive fabrication capabilities allow Johnson Screens to supply a wide range of customized framing and assembly options designed to meet individual customer needs.

Johnson Screens' technical department and engineering staff are available to help create the total profile wire system which is best suited to solve your specific application requirements.

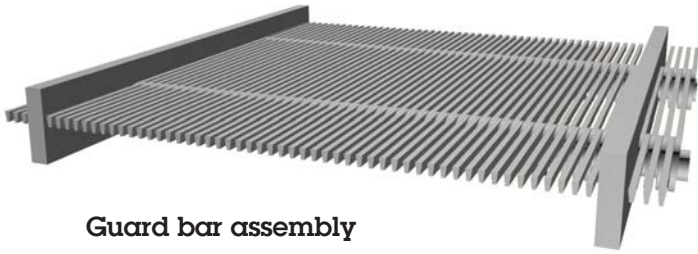

Guard bar assembly

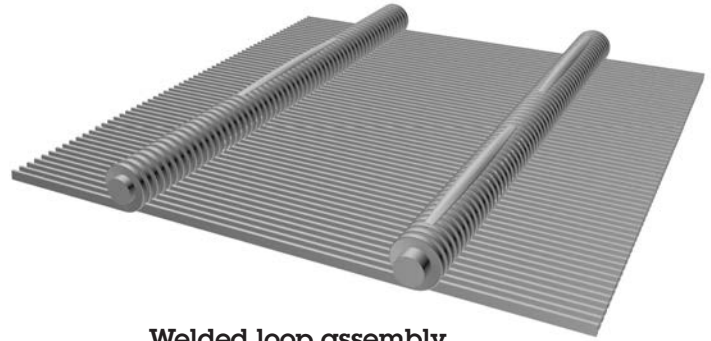

Welded loop assembly

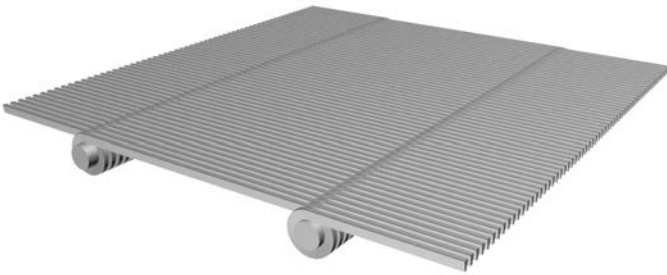

Mat section with no bushing

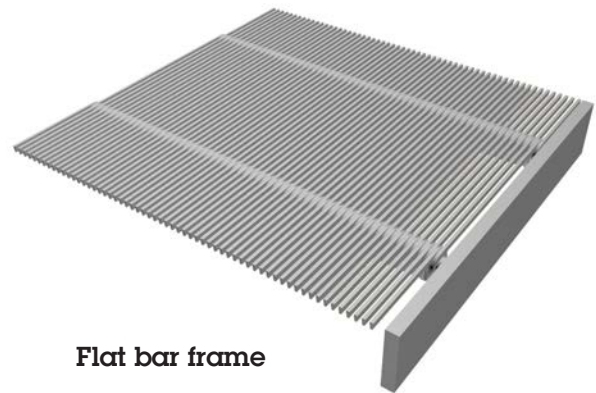

Flat bar frame

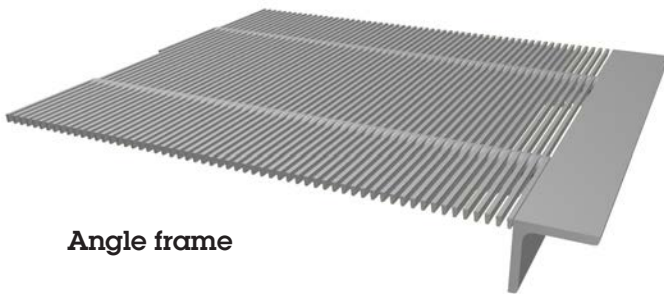

Angle frame

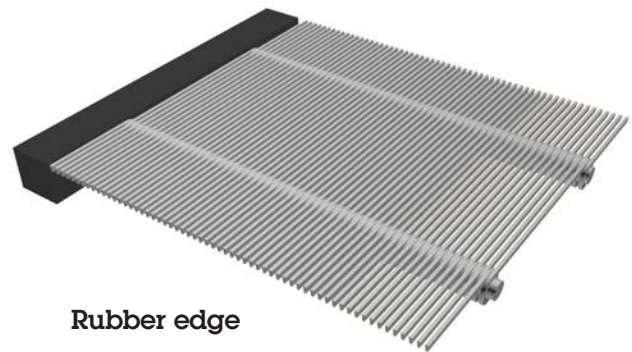

Rubber edge

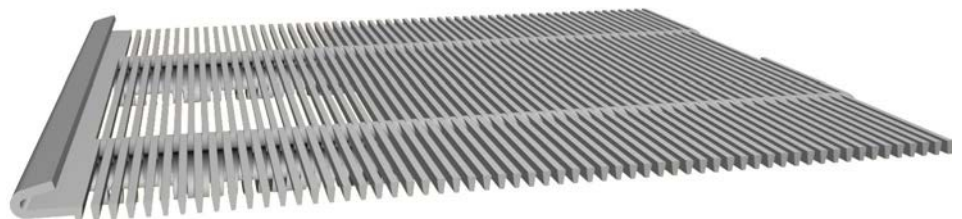

Hook Strip



Diamond Top

The "diamond" configuration of this profile wire surface acts to guide liquids toward openings and substantially increases screening efficiency. This action also agitates particles which helps in the prevention of material adhesion.

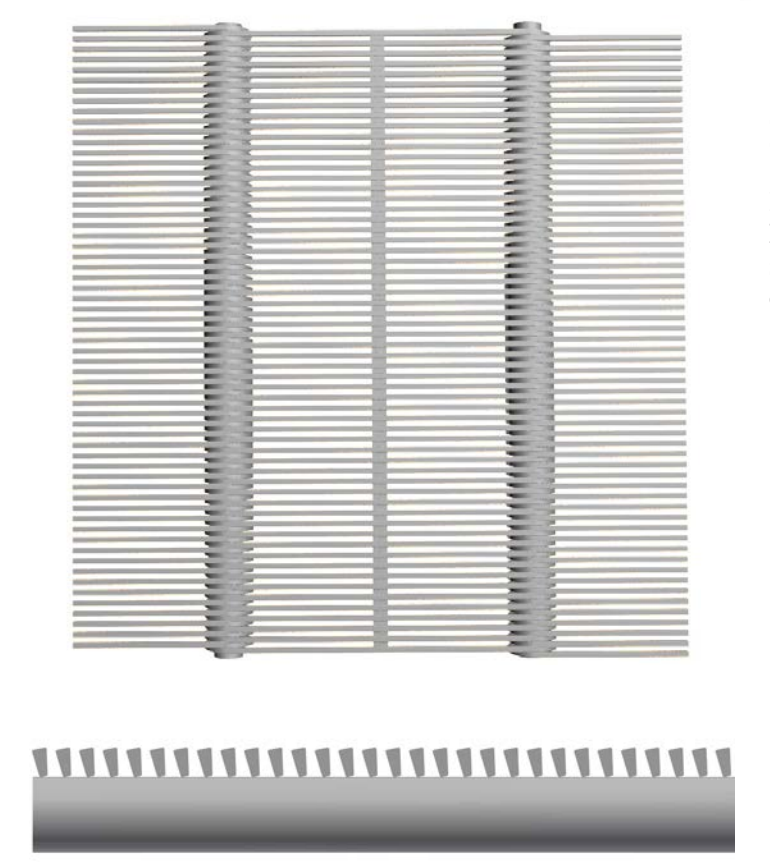

Blips

In severe screening applications, spacing blips can be placed in the profile wire between standard cross support rod loops. The spacing blips insure accurate and uniform slot openings during operation.

Tilt

The "tilting" of the profile wire angle, typically 5° to 10°, enhances the dewatering and separation of material on cross flow screening applications

Free-Flow

Free-Flow screens are made with a ribbon lock-bar process. This process incorporates cross-bars which are inserted into slotted longitudinal profile bars, rotated 90° and locked into place. The cross bars are then automatically welded on the underside only.

Free-Flow screens are typically used in high wear applications requiring a clear, free slotted screen surface. Free-Flow is available in openings of .010" and larger with total stainless steel construction.

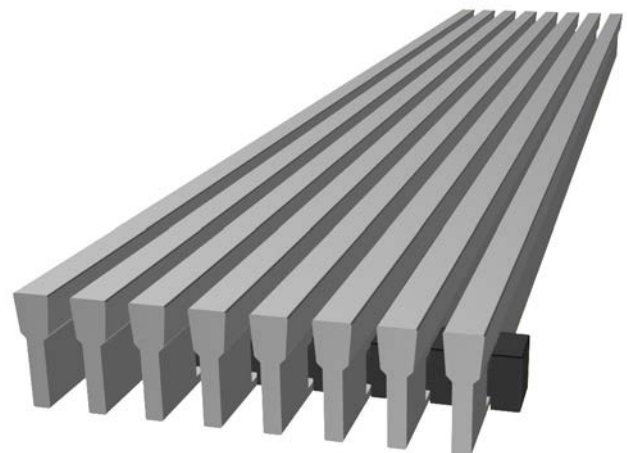

Wire and Rod Information

Vee-Wire® Profiles - Most Commonly Used

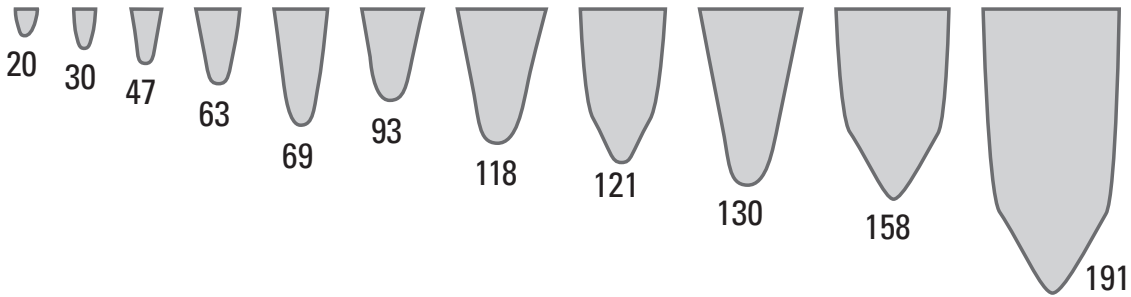

$$\text{Open Area (\%)} = \frac{\text{Slot Size} \times 100}{\text{Slot Size} + \text{Wire Width}}$$

Name	Width		Height		Section Area		Relief Angle
	in.	mm	in.	mm	in ²	mm ²	
20	0.020	0.508	0.040	1.016	0.0005	0.323	11°
30	0.030	0.762	0.050	1.270	0.001	0.645	13°
47	0.047	1.194	0.088	2.235	0.003	1.935	10°
63	0.060	1.524	0.100	2.540	0.004	2.581	13°
69	0.071	1.803	0.177	4.496	0.010	6.452	7°
93	0.089	2.261	0.138	3.505	0.009	5.806	13°
118	0.116	2.946	0.185	4.699	0.015	9.677	13°
130	0.130	3.302	0.250	6.350	0.023	14.839	8°
191	0.195	4.953	0.363	9.220	0.055	35.484	5°

Shaped Support Rods

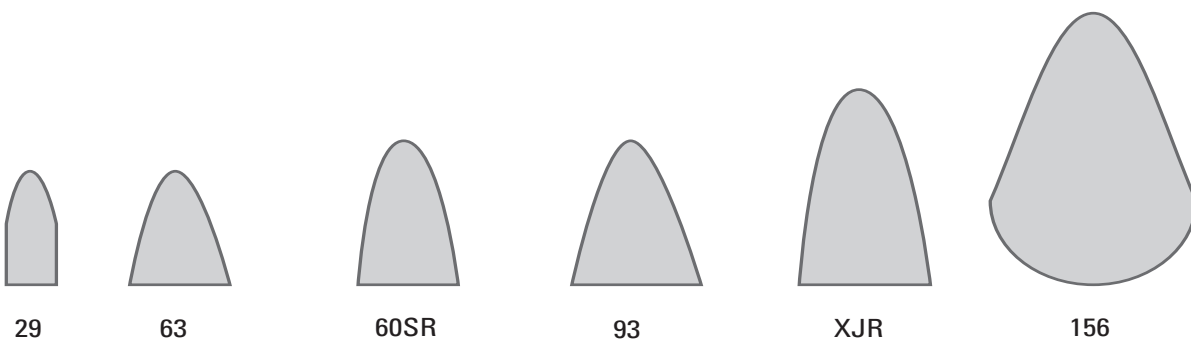

Name	Width		Height		Section Area		Section Modulus (in. ³ x 10 ⁻³)
	in.	mm	in.	mm	in.	mm	
29	0.029	0.737	0.102	2.591	0.003	0.076	0.037
63	0.060	1.524	0.100	2.540	0.004	2.581	0.050
93	0.089	2.261	0.138	3.505	0.009	5.806	0.150
XJR	0.089	2.261	0.189	4.801	0.013	0.330	0.298
60SR	0.060	1.524	0.120	3.048	0.006	0.152	0.077
156	0.151	3.835	0.217	5.512	0.022	0.559	0.600

Tri-Wire Profiles

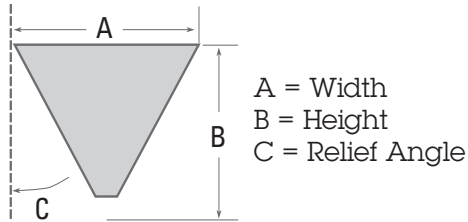

Wire Number	Width		Height		Relief Angle
	in.	mm	in.	mm	
93 TRI	0.093	2.388	0.070	1.956	30°
125 TRI	0.125	3.175	0.094	2.769	30°
188 TRI	0.188	4.775	0.141	4.369	30°
250 TRI	0.25	6.35	0.188	5.563	30°
500 TRI	0.50	12.7	0.469	11.913	30°

Examples of Screen Open Area

Wire No.	Percent of Open Area						Slot Opening Size (in.)
	20	30	40	50	60	70	
30	0.008	0.013	0.020	0.030	0.045	0.070	
47	0.012	0.020	0.031	0.047	0.071	0.110	
63	0.015	0.026	0.041	0.060	0.090	0.140	
69	0.018	0.030	0.047	0.071	0.107	0.166	
93	0.022	0.038	0.059	0.089	0.134	0.208	
118	0.029	0.050	0.077	0.116	0.174	0.271	
130	0.033	0.056	0.087	0.130	0.195	0.303	
158	0.040	0.068	0.105	0.158	0.237	0.369	
191	0.049	0.084	0.130	0.195	0.293	0.455	
250 TRI	0.063	0.107	0.167	0.250	0.375	0.583	
500 TRI	0.125	0.214	0.333	0.500	0.750	1.167	

Standard Welded Construction

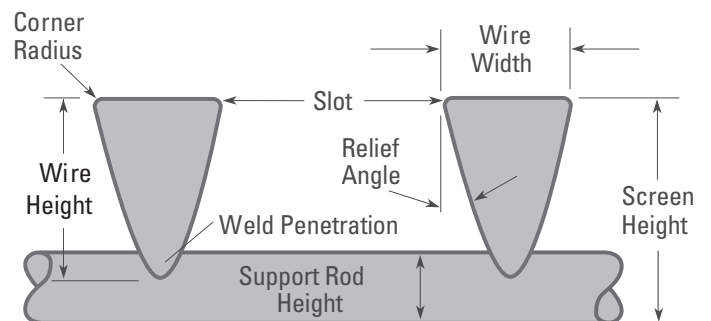

Round and Strip Rods

- Round rods are available in diameters ranging from 0.125 to 0.500 in. (3.175 to 12.7 mm).
- Strip rods are available in widths ranging from 0.070 to 0.188 in. (1.778 to 4.775 mm) and heights ranging from 0.375 to 2.0 in. (9.525 to 50.8 mm).

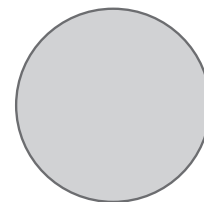

Aqseptence Group, Inc.
Industrial & Architectural Screens

North America

Phone +1 651 636 3900

Fax +1 651 638 3171

info.johnsonscreens.us@aqseptence.com

Australia - Asia Pacific

Phone +61 7 3867 5555

Fax +61 7 3867 5566

info.johnsonscreens.au@aqseptence.com

Europe

Phone +33 5 49021600

Fax +33 5 49021616

info.johnsonscreens.fr@aqseptence.com

India

Phone +91 2764 281007 / 281220 / 281221

Fax +91 2764 281028

info.johnsonscreens.in@aqseptence.com

Japan

Phone +81 45 661 3575

Fax +81 45 661 1921

info.johnsonscreens.jp@aqseptence.com

Argentina

Phone +54 11 4714 6699

Fax +54 11 4714 2175

info.johnsonscreens.ar@aqseptence.com

Brazil

Phone +55 11 4341-5777

Fax +55 11 4393-0414

info.johnsonscreens.br@aqseptence.com

Chile

Phone +56 02 9280700

Fax +56 02 9280705

info.johnsonscreens.cl@aqseptence.com

www.aqseptence.com