

## Flush Thread PVC Well Screens, Casings and Accessories

A full line of PVC products that include: Vee-Wire® well screens, slotted well screens, casings and accessories for the water supply and environmental industries. In water supply applications PVC can offer an economical and long-lasting design option, especially when used with a Johnson Screens stainless steel screens.



**Polyvinyl chloride (PVC) - Is economical, light weight and its design flexibility makes it ideal for:**

- Water wells
- Water monitoring wells
- Soil vapor extraction
- Sparging - air or oxygen
- Bioremediation
- Free product recovery
- Groundwater extraction
- Drainage and dewatering
- Leachate collection
- Degassing

**Among the fabricating options:**

- PVC casing and well screens from 0.50 to 18 in. diameter
- Plain end, flush joint or NPT threaded
- Threaded products supplied in laying lengths
- Slot openings from 0.006 in. to 0.500 in.
- Environmental products hermetically sealed in plastic
- Round hole perforated pipe from 1 in. to 16 in. diameter

### **More Design Options**

The flexibility to specify and design a wide variety of slot openings, diameters and wall thicknesses allows the well designer to create a well for a wide range of depths and applications.

Johnson Screens' PVC well products are designed and manufactured to industry standards, with tolerances that meet or exceed customer needs. This results in a long-lasting well that requires less maintenance.

### **Customer Support**

An experienced and knowledgeable customer service representatives, technical support staff and engineers, provide customers with solutions to a variety of issues, including screen and casing size recommendations, installation suggestions and sieve analysis.

### **Locally Available**

With an extensive distributor network, the Johnson Screens brand is available to customers at a number of distributors throughout the world.

# Flush Threaded PVC Casing and Slotted Pipe Specifications

All Johnson Screens Flush Threaded PVC pipe and screen products are manufactured from plastic of Type 1, Grade 1, PVC compound with a cell classification of 12454-B per ASTM D1784. Pipe materials are NSF approved for potable water and are in strict compliance with ASTM D1785.

To maintain the integrity of the slotting and threading process, the only coolant used is air.

## Physical Data For Common Size Pipe schedule 40, 80, 120 and large diameter SDR 17\*

Nominal Pipe Size (in.)	O.D. (in.)	Sch. 40			Sch. 80			Sch. 120/SDR 17		
		Avg I.D. (in.)	Min Wall (in.)	Nom Wt. (lbs./ft.)	Avg I.D. (in.)	Min Wall (in.)	Nom Wt. (lbs./ft.)	Avg I.D. (in.)	Min Wall (in.)	Nom Wt. (lbs./ft.)
0.5	0.84	0.60	0.11	0.17	0.53	0.15	0.21	0.48	0.17	0.24
0.75	1.05	0.80	0.11	0.23	0.72	0.15	0.29	0.69	0.17	0.31
1	1.32	1.03	0.13	0.33	0.94	0.18	0.42	0.89	0.20	0.46
1.25	1.66	1.36	0.14	0.45	1.26	0.19	0.59	1.20	0.22	0.65
1.5	1.90	1.59	0.15	0.54	1.48	0.20	0.71	1.42	0.23	0.79
2	2.38	2.05	0.15	0.72	1.91	0.22	0.98	1.85	0.25	1.11
2.5	2.88	2.45	0.20	1.14	2.29	0.28	1.50	2.24	0.30	1.62
3	3.50	3.04	0.22	1.49	2.86	0.30	2.01	2.76	0.35	2.31
4	4.50	4.00	0.24	2.12	3.79	0.34	2.94	3.57	0.44	3.71
5	5.56	5.02	0.26	2.87	4.77	0.38	4.08	4.37	0.50	5.00
6	6.63	6.03	0.28	3.73	5.71	0.43	5.61	5.43	0.56	7.13
8	8.63	7.94	0.32	5.62	7.57	0.50	8.52	7.27	0.51	8.40
10	10.75	9.98	0.37	7.97	9.49	0.59	12.64	9.38	0.63	13.27
12	12.75	11.89	0.41	10.53	11.29	0.69	17.38	11.13	0.75	18.89
14	14.00	13.07	0.44	12.46	12.41	0.75	20.85	12.21	0.83	22.55
16	16.00	14.94	0.50	16.29	14.21	0.84	26.81	13.95	0.94	31.66
18	18.00	16.81	0.56	20.59	16.01	0.94	33.54	15.78	1.06	35.60

### \*Based on GF Harvel Engineering Guide

Custom lengths up to 20 ft. can be provided on request. Laying (makeup) length is standard for commonly used materials such as 1, 2, 4, 6 in. diameter Schedule 40 and 80 PVC. Other sizes are end-to-end length unless specified. Standard threads per inch (TPI), for pipe sized .5 - 1 in. is 8 TPI, 1.25 - 1.5 in. is 4 TPI, and 2 in. and up is 2 TPI. Customized screen products for special pipe lengths, slot sizes, slot spacing and thread types are available to meet specifications. All flush threaded material is supplied with an O-ring. All environmental screens and casings, up to 8 in. diameter, are cleaned and bagged prior to shipment.

## Temperature De-Rating Table

Curing of cement and grout generates sufficient heat to affect PVC strength and performance. When operating at elevated temperatures, the actual values for Collapse Pressure, Burst Pressure and Tensile Strength will be de-rated according to the chart.

Operating Temp. (°F / °C)	Strength De-Rating Factor
73 / 23	1.00
80 / 27	0.88
90 / 32	0.75
100 / 38	0.62
110 / 44	0.51
120 / 49	0.40
130 / 54	0.31
140 / 60	0.22

# Pressure and Strengths

Testing methods and procedures used are in compliance with ASTM F480 standards for thermoplastic pipe in all applicable areas.

Nominal Pipe Size (in.)	Collapse Pressure (psi)*			Tensile Strength (lb)**		
	Sch. 40	Sch. 80	Sch. 120/ SDR 17	Sch. 40	Sch. 80	Sch. 120/ SDR 17
0.5	1,400	3,800	6,240	360	340	540
0.75	750	2,100	2,890	460	490	730
1	600	1,600	2,350	700	730	1,000
1.25	300	900	1,370	920	880	1,400
1.5	250	700	1,020	1200	1,200	1,700
2	150	450	700	1500	1,500	2,400
2.5	200	520	680	2,000	2,900	3,600
3	130	360	590	3,000	3,800	5,300
4	80	240	540	4,400	5,800	8,800
5	50	170	420	5,700	6,800	12,400
6	40	150	350	7,100	11,000	17,200
8	30	100	113	11,400	18,400	18,400
10	20	90	113	15,000	26,300	26,300
12	17	85	113	19,500	36,200	36,200
14	16	80	113	22,900	43,400	43,400
16	16	80	113	28,900	55,100	55,100
18	16	75	113	36,000	71,000	71,000

## Notes:

- Values noted with an asterisk (\*) are based on minimum wall and include a 50% safety factor. These values are based on ASTM Standards where appropriate. Values noted with a double asterisk (\*\*) are recommended dry hanging weights for threaded PVC. These values are calculated based on the minimum cross sectional area of either the box or pin thread portion of the joint after machining. The resulting minimal area was multiplied by 7,000 psi tensile strength per ASTM D-1784 to yield the recommended dry hanging weight. Safety factor: even though these calculated values are lower than actual Johnson Screens test data, Johnson Screens recommends not to exceed the above values for well construction.
- All strength properties are based on 73° F

## Collapse Pressure

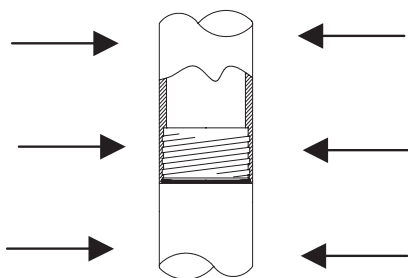

Pounds per square inch of external hydrostatic pressure that can be safely applied.

## Tensile Strength

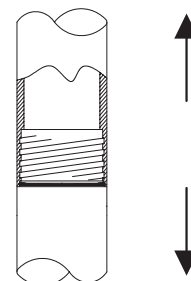

The suspended weight the threaded joint can sustain in a vertical position without causing stretching or failure.

# Slotted Screens and Open Area

The following tables represent the standard open area of the Johnson Screens slotted PVC well screen. All calculations are based on the inside diameter of the pipe which represents the most accurate area and transmitting potential of the screen. The data presented in these tables is for standard product line. To calculate transmitting capacity in gpm at 0.1 ft/sec flow velocity, multiply the open area of square inches by 0.31.

## Slotted Screen Open Area in Square Inches Per Foot for Schedule 40 — Std. Construction

Nominal Pipe Size (in.)	Standard Slot Opening (in.)									
	0.010	0.015	0.020	0.025	0.030	0.040	0.050	0.060	0.100	0.125
0.5	0.8	1.1	1.5							
0.75	0.8	1.2	1.6							
1	1.1	1.7	2.2	2.7	3.1	3.1	3.8	4.4	6.4	5.6
1.25	1.7	2.5	3.3	4.0	4.7	4.7	5.6	6.5	9.6	8.4
1.5	2.1	3.0	3.9	4.8	5.6	5.6	6.8	7.8	11.6	10.1
2	3.6	5.1	6.6	8.0	9.3	6.6	8.0	9.3	13.7	11.3
2.5	4.2	6.1	7.9	9.5	11.0	7.9	9.5	11.0	16.3	14.3
3	4.7	6.8	8.7	10.5	12.2	9.9	12.0	13.9	20.6	18.0
4	6.0	8.7	11.2	13.5	15.7	11.2	13.5	15.7	23.1	18.0
5	6.3	9.2	11.8	14.3	16.6	13.0	15.8	18.3	27.0	23.6
6	6.2	9.0	11.6	13.1	15.4	19.9	24.0	27.9	41.1	36.0
8	6.5	9.5	12.4	15.3	18.0	23.2	28.0	32.5	48.0	42.0
10			14.2	17.5	20.6	26.5	32.0	37.2	54.9	48.0
12			18.3	22.5	26.5	34.1	41.3	47.9	70.7	61.9
14						27.5	33.5	39.3	60.0	71.3
16							36.2	42.4	64.7	76.9
18							45.9	53.8	82.1	97.5

Custom slot patterns and slot sizes available on request

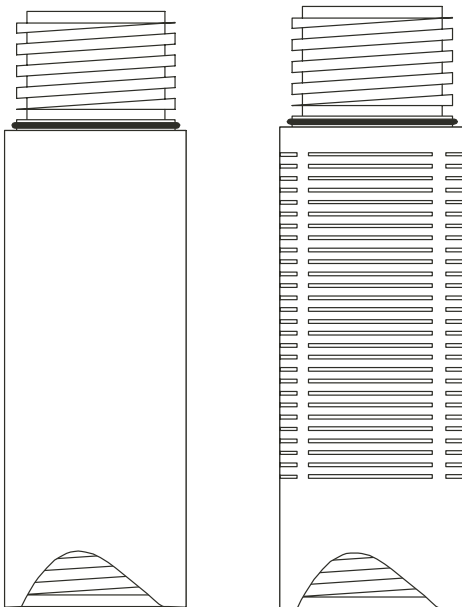

### Among some of the fabricating options for casing and screen:

- Plain end, flush joint or NPT threaded
- Threaded products supplied in laying lengths
- Slot openings from 0.006 to 0.500 in.

## Slotted Screen Open Area in Square Inches Per Foot for Schedule 80 — Std. Construction

Nominal Pipe Size (in.)	Standard Slot Opening (in.)									
	0.010	0.015	0.020	0.025	0.030	0.040	0.050	0.060	0.100	0.125
0.5	0.6	0.9	1.2							
0.75	0.7	0.9	1.2							
1	0.9	1.3	1.7	2.1	2.5	2.5	3.0	3.5	5.1	4.5
1.25	1.5	2.2	2.8	3.4	4.0	3.7	4.5	5.2	7.7	6.8
1.5	1.7	2.5	3.3	4.0	4.7	4.7	5.6	6.5	9.6	8.4
2	2.9	4.2	5.4	6.5	7.6	5.4	6.5	7.6	11.1	9.0
2.5	3.6	5.1	6.6	8.0	9.3	6.6	8.0	9.3	13.7	11.3
3	4.0	5.8	7.5	9.0	10.5	8.7	10.5	12.2	18.0	15.8
4	4.7	6.8	8.7	10.5	12.2	11.6	14.0	16.3	24.0	21.0
5			6.7	8.2	9.6	12.4	15.0	17.4	25.7	24.0
6			8.7	10.6	12.5	16.1	19.5	22.7	33.4	29.3
8					13.5	17.4	21.0	24.4	36.0	42.8
10					11.1	14.5	17.7	20.7	31.6	37.5
12						22.0	26.8	31.5	48.0	57.0
14						23.7	28.9	33.9	51.8	61.5
16							31.8	37.2	56.8	67.5
18							34.4	40.4	61.6	73.1

Custom slot patterns and slot sizes available on request

## Environmental Monitoring Application

Manufacturing a complete line of PVC well screens, casings and accessories suited for groundwater monitoring and remediation, Johnson Screens products meet manufacturing techniques and process requirements of the environmental and remediation markets.

Johnson Screens can provide the following:

- No printing on screen or pipe
- Cleaned and bagged
- Flush thread connections
- O-rings that are pre-installed
- Boxed or bulk package options

# Shur-Grip® PVC Pipe

Threaded Schedule 80, 120 and SDR 17 PVC pipe, with a unique holding groove, allows for easy and fast installation when handling large diameter or heavy casing and screen strings.

- Installation is fast and easy using Male x Female Flush Joint Threaded Shur-Grip PVC Pipe
- Each Shur-Grip PVC Pipe includes a Holding Groove that encircles the female end for trouble-free installation using elevators
- Shur-Grip PVC Pipe is available in Casing and Slotted Screen, in lengths up to 20 feet
- A smooth wall allows for better installation of filter pack and grout in smaller boreholes
- No splines needed

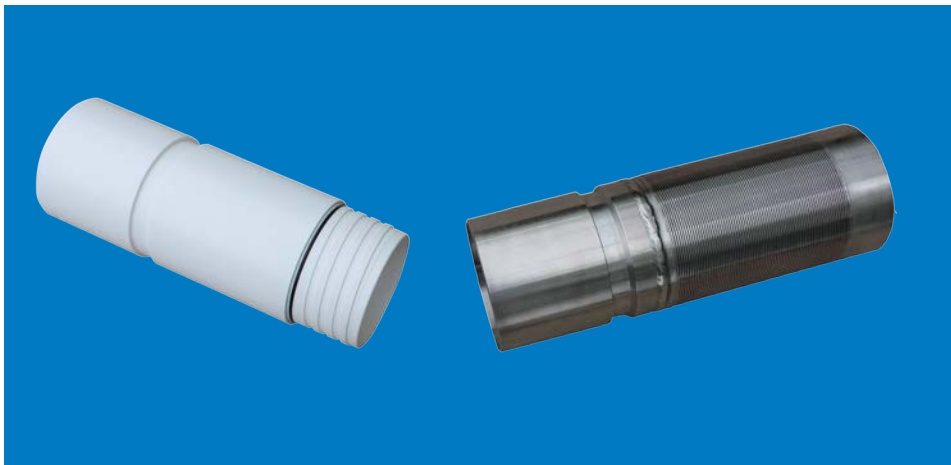

Shur-Grip hybrid well connection to a Johnson Screens' of stainless steel well screen. Shur-Grip casing can also connect to a Johnson Screens brand of PVC well screen.

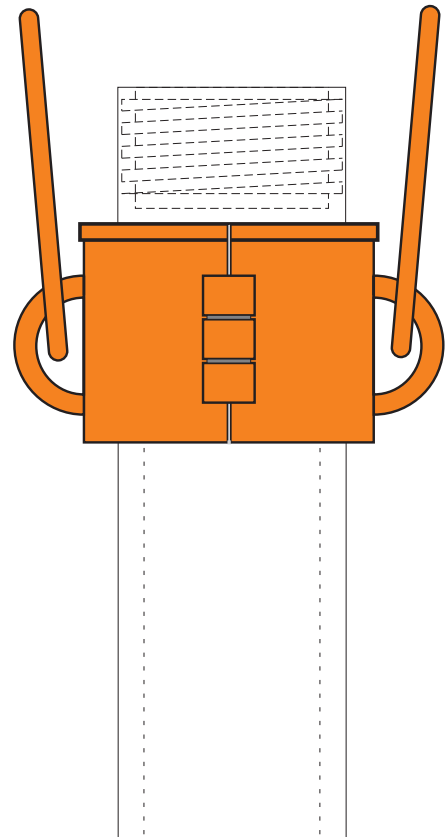

## Perforated Pipe



Leachate or drainage applications often require that PVC products used in flow collection have perforation patterns matched to the specific site conditions. Our engineers help you determine the spacing and size of the perforations which gives you the best flow collection, while retaining the landfill or earthen materials.

- 1 in. to 16 in. diameter
- Up to 20 ft. length
- Plain end x plain end, belled, or threaded
- PVC, CPVC, and HDPE (all schedules and SDR's)
- 1/16 in. to 1 in. diameter holes
- 8 Row maximum, staggered or non staggered patterns

# PVC Vee-Wire

Commonly used in shallow wells, PVC Vee-Wire screens present higher open area screen available in PVC. PVC Vee-Wire screens resist corrosion from aggressive waters and are ideal for many environmental applications. PVC screens are furnished with F480 flush threads or plain ends for connecting to Johnson Screens PVC fittings.

Pipe Size (in.)	Nominal O.D. (in.)	Dia. I.D. (in. <sup>1</sup> )	Weight/ ft. (lbs.)	Tensile Strength (lbs) <sup>2</sup>	Hang Weight (lbs.) <sup>4</sup>	Open Area (sq in.) Per Foot of Screen Collapse Strength - PSI <sup>3</sup>					
						Screen Slot Size (in.)					
						0.006	0.010	0.020	0.030	0.040	0.050
1 - 1/4 PS	1.7	1.2	0.7	780	195	3.1	4.9	9.2	12.8	16.0	18.9
						270	260	240	230	210	200
1- 1/2 PS	1.9	1.5	0.8	1200	310	3.4	5.5	10.2	14.3	17.9	21.1
						180	180	160	150	140	130
2P/3T	2.4	1.9	0.8	1300	330	4.3	7.0	12.9	18.1	22.6	26.6
						95	92	85	79	74	70
2 PS*	2.6	2.0	0.9	1300	330	4.7	7.5	14.0	19.6	24.5	28.8
						72	70	65	61	57	54
3 PS	3.5	2.9	1.5	1800	460	5.4	8.8	16.5	23.3	29.3	34.7
						170	160	150	150	140	130
4 Special	4.5	3.9	1.7	2100	530	7.0	11.3	21.2	29.9	37.7	44.6
						81	78	74	69	65	62
4 PS*	4.6	4.0	1.8	2100	530	7.1	11.6	21.7	30.6	38.5	45.6
						75	73	68	64	60	57
5 PS	5.7	4.9	2.5	3900	980	8.3	13.4	25.3	35.8	45.2	53.7
						73	72	68	65	62	59
6 PS	6.6	5.9	3.7	4600	1200	8.0	13.1	24.9	35.5	45.2	54.1
						73	72	68	65	62	59
8 PS	8.8	7.6	4.6	5500	1400	13.6	22.1	41.5	58.6	73.7	87.3
						60	59	55	52	49	46

1. Clear ID's are minimum inside diameters
2. Tensile values are based on support rod area, other values are based on flush-thread test values
3. Collapse strengths are calculated values - no safety factor included
4. Hang weights are the maximum combined weight of riser and screen to be hung from the top screen joint
5. All strength properties are based on 73° F
6. Alternate construction for environmental applications

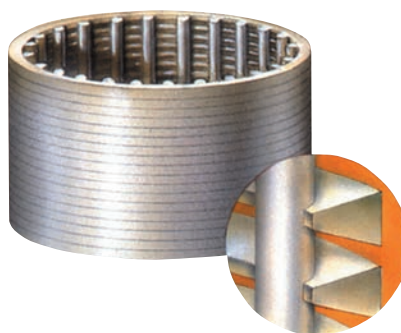

Designs up to 6 in. are made with standard rod base.

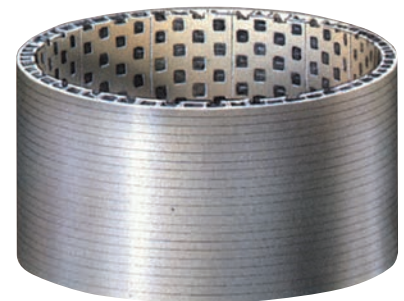

The 8 in. design features a channel-rod base for enhanced strength.

\*Alternate construction for environmental applications



# Vee-Pack™ PVC Pre-Packed Screens

Some subsurface conditions, such as heaving and very-fine sands, make conventional filter pack placement difficult or impossible. The solution is a Johnson Screens Vee-Pack screen that has an integral filter pack that creates a filter pack that is 100% void-free. Available with either Schedule 40 or 80 threads.

Vee-Pack Specifications										
Pipe Size (in.)	Diameter		Standard Length <sup>b</sup> (ft.)	Open Area (sq. in./ft.) <sup>c</sup>				Strength <sup>s</sup>		
	O.D. (in.)	I.D. <sup>a</sup> (in.)		40X60 Pack (8-Slot)	20X40 Pack (10-Slot)	20X40 Pack (12-Slot)	10X20 Pack (20-Slot)	Collapse <sup>c</sup> (psi)	Tensile <sup>e</sup> (lbs)	Hanging <sup>f</sup> wt. (lbs)
2	3.5	2.0	2.5, 5, 10	6.1	7.5	8.9	14.0	250	1,300	420
4	5.7	4.0	2.5, 5, 10	9.4	11.6	13.7	21.7	150	2,100	520

a. Clear I.D.s are dimensions with fittings attached

b. Lengths are measured shoulder-to-shoulder

c. Open areas and collapse are based on inner screen

d. Strength properties are established at 73° F

e. Tensile is based on area of inner screen rods

f. Hanging weight is maximum weight on the top screen

## Vee-Pack has More Open Area than a Slotted Pre-Packed Screens

Whether it is sampling or water extraction/production, more open area will aid development and create a better well for its intended purpose. The table below presents the open area for typical slot sizes used in pre-packed screens – Vee-Pack is far superior in open area.



### Comparison of Vee-Pack and Slotted PVC Pre-Packed Screens

Pipe Size (in.)	PVC Pre-Packed Product	Open Area (sq. in./ft.) <sup>a</sup>		
		40X60 Pack (8-Slot)	20X40 Pack (12-Slot)	10X20 Pack (20-Slot)
2	Vee-Pack	6.1	8.9	14.0
	Slotted	2.0	4.2	6.6
4	Vee-Pack	9.4	13.7	21.7
	Slotted	3.3	7.1	11.2

a. Based on the open area of the inner screen - for slotted products, assumes slots at .25 in. nominal spacing.



# PVC Fittings and Adapters

We offer a wide range of PVC fittings and adapters for use with our well screens. These items include both Schedule 40 and 80 male plugs, female caps, male and female points, male and female lifting baits, as well as several slip fittings.

Our female fittings can fit Schedule 120 pipe and custom fittings for all of our PVC products are also available. Contact us to help select the right fitting for your project.

## PVC Fittings

Dia. (in.)	Female and Male Plugs/Caps	Female and Male Points	Male NPT x Female FST Adapters	Mail Lifting Bail	Male Slip Point	Male Slip Bottom	Female Slip Cap	Female Slip Coupling
.50	Sch. 40 & Sch. 80	Sch. 40 & Sch. 80	Sch. 40 & Sch. 80		Sch. 40		Sch. 40 & Sch. 80	Sch. 40 & Sch. 80
.75	Sch. 40 & Sch. 80	Sch. 40 & Sch. 80	Sch. 40 & Sch. 80		Sch. 40		Sch. 40 & Sch. 80	Sch. 40 & Sch. 80
1	Sch. 40 & Sch. 80	Sch. 40 & Sch. 80	Sch. 40 & Sch. 80		Sch. 40	Sch. 40	Sch. 40 & Sch. 80	Sch. 40 & Sch. 80
1.25	Sch. 40 & Sch. 80	Sch. 40 & Sch. 80	Sch. 40 & Sch. 80		Sch. 40	Sch. 40	Sch. 40 & Sch. 80	Sch. 40 & Sch. 80
1.50	Sch. 40 & Sch. 80	Sch. 40 & Sch. 80	Sch. 40 & Sch. 80		Sch. 40	Sch. 40	Sch. 40 & Sch. 80	Sch. 40 & Sch. 80
2	Sch. 40 & Sch. 80	Sch. 40 & Sch. 80	Sch. 40 & Sch. 80	Sch. 40 & Sch. 80	Sch. 40	Sch. 40	Sch. 40 & Sch. 80	Sch. 40 & Sch. 80
3	Sch. 40 & Sch. 80	Sch. 40 & Sch. 80	Sch. 40 & Sch. 80	Sch. 40 & Sch. 80			Sch. 40 & Sch. 80	Sch. 40 & Sch. 80
4	Sch. 40 & Sch. 80	Sch. 40 & Sch. 80	Sch. 40 & Sch. 80	Sch. 40 & Sch. 80	Sch. 40	Sch. 40	Sch. 40 & Sch. 80	Sch. 40 & Sch. 80
5	Sch. 40 & Sch. 80	Sch. 40 & Sch. 80	Sch. 40 & Sch. 80	Sch. 40 & Sch. 80	Sch. 40	Sch. 40	Sch. 40 & Sch. 80	Sch. 40 & Sch. 80
6	Sch. 40 & Sch. 80		Sch. 40 & Sch. 80	Sch. 40 & Sch. 80			Sch. 40 & Sch. 80	Sch. 40 & Sch. 80
8	Sch. 40 & Sch. 80		Sch. 40 & Sch. 80	Sch. 40 & Sch. 80			Sch. 40 & Sch. 80	Sch. 40 & Sch. 80
10	Sch. 40 & Sch. 80		Sch. 40 & Sch. 80	Sch. 40 & Sch. 80			Sch. 40 & Sch. 80	Sch. 40 & Sch. 80
12	Sch. 40 & Sch. 80			Sch. 40 & Sch. 80			Sch. 40 & Sch. 80	Sch. 40 & Sch. 80
14	Sch. 40 & Sch. 80			Sch. 40 & Sch. 80			Sch. 40 & Sch. 80	Sch. 40 & Sch. 80
16	Sch. 40 & Sch. 80			Sch. 40 & Sch. 80			Sch. 40 & Sch. 80	Sch. 40 & Sch. 80
18	Sch. 40 & Sch. 80			Sch. 40 & Sch. 80			Sch. 40 & Sch. 80	Sch. 40 & Sch. 80

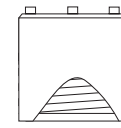

Female Cap



Male Plug

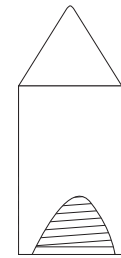

Female Point

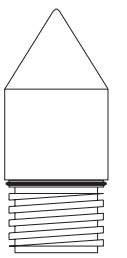

Male Point

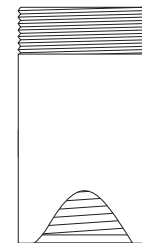

Male NPT x Female FJT Adapter

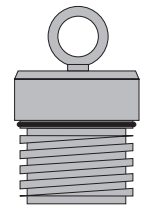

Male Lifting Bail

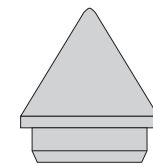

Slip Point

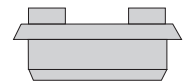

Slip Bottom

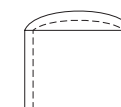

Slip Cap

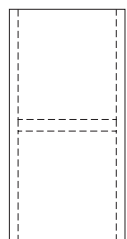

Slip Coupling

# HDPE Hollow Stem Auger Plugs

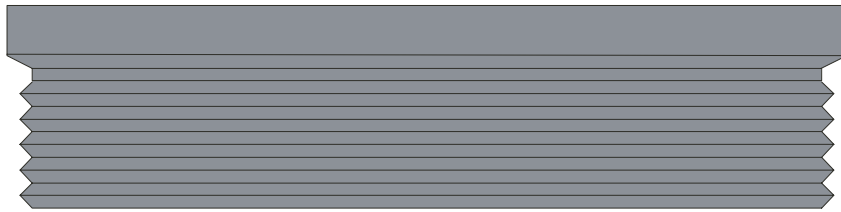

Dia (in.)
2.25
3.25
4.25
4.375
6.25
6.625
8.25
10.25
12.25

## Locking Plugs

### 1/2 in. — 8 in. Diameter

Heavy duty locking plugs constructed of glass-filled nylon plastic are placed inside the well casing to prevent unauthorized access to the monitoring well. As the wing-bolt is tightened, a Buna-N gasket seal expands against the casing wall to seal the well. Each size will accommodate an optional #3 padlock. 2 in., 4 in., and 6 in. diameter plugs fit Schedule 40 PVC or steel pipe. Each unit comes individually boxed.



## Locking Plugs

### 1/2 in. — 6 in. Diameter, Schedule 40 and 80

- Domed Top
- No Metal Parts
- Nylon Construction with U/V Inhibitor Added
- Dual One piece Santoprene Gasket
- Unaffected by freezing or extreme heat
- Accepts #1 or #3 Pad Locks
- Monitoring well / no fill markings



## Stainless Steel Centralizers

"High Strength Worm Drive" Centralizers. No nut to lose or drop down the well. Can be assembled with a nut driver, screwdriver, wrench or socket, are 100% stainless steel. They provide a lower profile than a "T-bolt" type centralizer.

Size (in.)	Hole Adjustment	Weight (lbs.)
2	2 in. up to 12 in.	0.5
4	4 in. up to 16 in.	0.8
6	6 in. up to 18 in.	1.0

Available Sizes: 1 in. through 18 in.

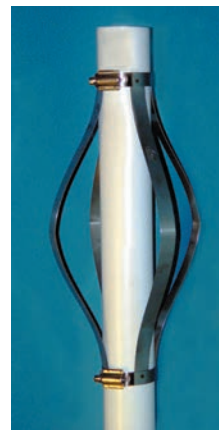

# PVC Surge Blocks

Johnson Screens PVC Surge Blocks are used in well rehabilitation or well development. These units come standard with a Female FJT Thread on one end and a Male NPT Thread on the other end. They are constructed of PVC and HDPE and are designed to fit the I.D. of Schedule 40 PVC pipe.

ID (in.)	Sch.	Pipe Ends
2	40	1 in. Male NPT x Female 8TPI
4	40	1.25 in. Male NPT x Female 4TPI
6	40	2 in. Male NPT x Female 2TPI

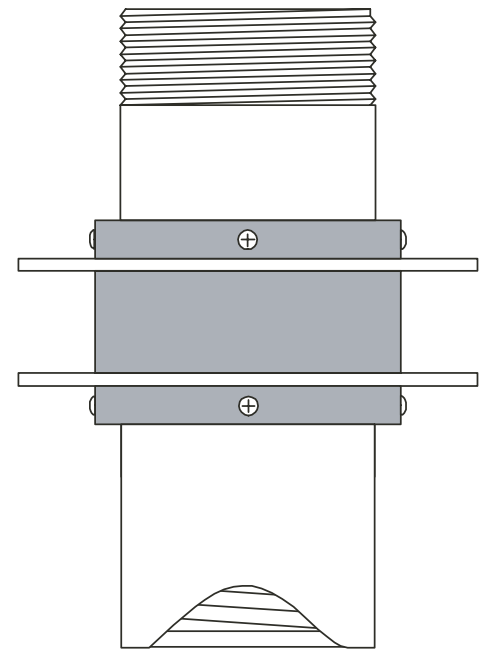

# Grouting Caps

Our Grouting Cap comes complete with a 1in. Schedule 40 PVC Female F480 x Left Hand Adapter for easy removal when check ball seals are off and grouting is complete. Grouting Caps are available for 4 in. through 12 in. Schedule 40 F480 Pipe.

Model	Fits Pipe Size	Grouting Pipe
GC-4	4 in. Sch. 40	1 in. Sch. 40
GC-5	5 in. Sch. 40	1 in. Sch. 40
GC-6	6 in. Sch. 40	1 in. Sch. 40
GC-8	8 in. Sch. 40	1 in. Sch. 40
GC-10	10 in. Sch. 40	1 in. Sch. 40
GC-12	12 in. Sch. 40	1 in. Sch. 40

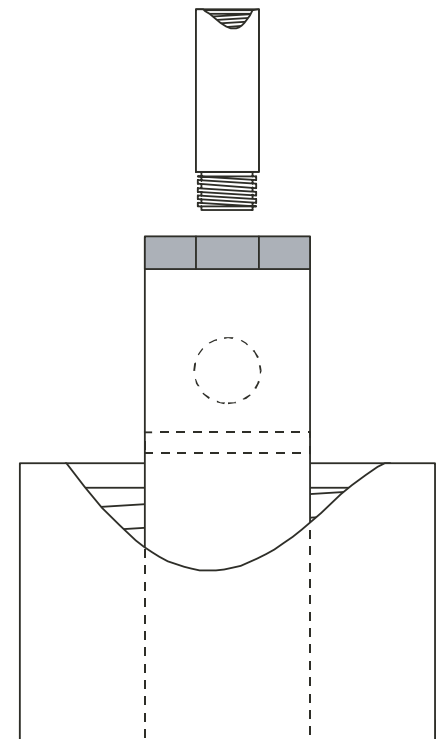

# Groundwater & Wells

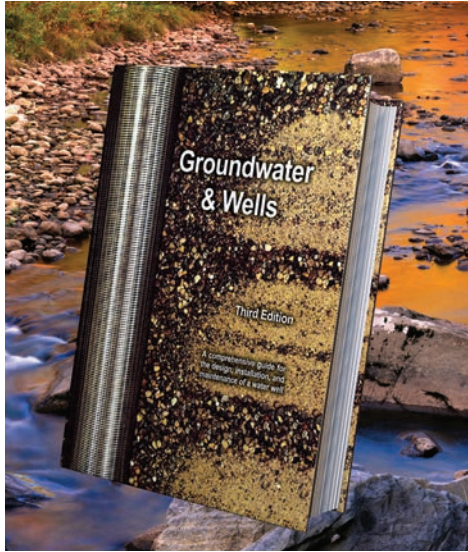

Recognized worldwide by engineers, scientists and well drillers, *Groundwater & Wells*, Third Edition, is used as the authoritative text on hydrogeology, well hydraulics, design, construction and materials and is available for purchase at [www.jswaterwell.com](http://www.jswaterwell.com).

*Groundwater and Wells*, Third Edition, includes comprehensive coverage of the accepted practices in well management, and is a valuable tool for anyone who designs, specifies, drills, samples, manages, or interprets data from monitoring or recovery wells

# Chemical Cleaning, Disinfection & Decontamination of Water Wells

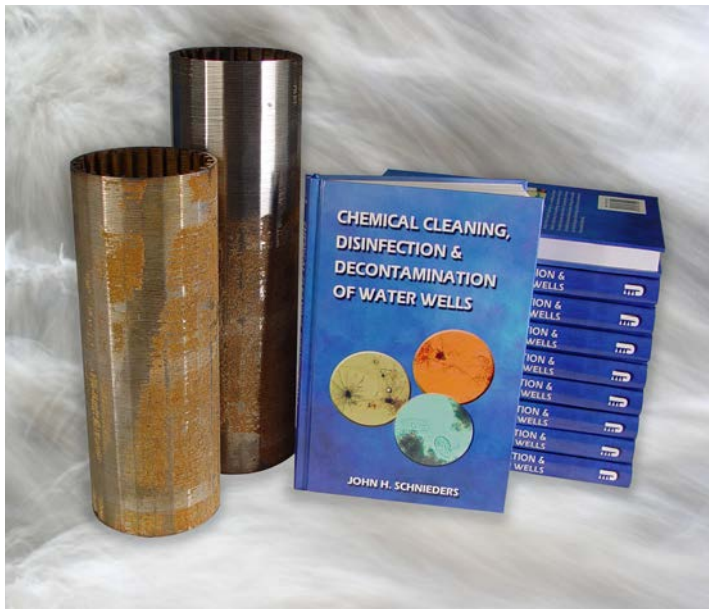

*Chemical Cleaning, Disinfection & Decontamination of Water Wells* book is a concise, complete assessment of the important role certain chemicals play in modern water treatment, water system construction and maintenance programs.

Included in this text are complete descriptions of chemicals frequently used in water supply applications. With a focus on effective and efficient use of chemicals, individually or in combination, to achieve better well rehabilitation, water system cleaning and water quality treatment.

Diagrams, formula mixer ratios and other technical data are included, along with proper handling techniques for each chemical and, where appropriate, clear warnings about possible hazards and the conditions that can cause them.

*Chemical Cleaning, Disinfection & Decontamination of Water Wells* book is in a convenient format for use on job sites, as well as classrooms and labs.

## Aqseptence Group, Inc. Water Well Screens

North and South America  
Phone +1 651 636 3900  
Fax +1 651 638 3177  
[waterwell.johnscreens.us@aqseptence.com](mailto:waterwell.johnscreens.us@aqseptence.com)  
[www.aqseptence.com](http://www.aqseptence.com)